

# INSTRUCTION MANUAL

POWER MODULE

TM 503

Serial Number \_\_\_\_\_



## WARRANTY

All TEKTRONIX instruments are warranted against defective materials and workmanship for one year. Any questions with respect to the warranty should be taken up with your TEKTRONIX Field Engineer or representative.

All requests for repairs and replacement parts should be directed to the TEKTRONIX Field Office or representative in your area. This will assure you the fastest possible service. Please include the instrument Type Number or Part Number and Serial Number with all requests for parts or service.

Specifications and price change privileges reserved.

Copyright © 1972 by Tektronix, Inc., Beaverton, Oregon. Printed in the United States of America. All rights reserved. Contents of this publication may not be reproduced in any form without permission of Tektronix, Inc.

U.S.A. and foreign TEKTRONIX products covered by U.S. and foreign patents and/or patents pending.

TEKTRONIX is a registered trademark of Tektronix, Inc.

# TABLE OF CONTENTS

	Page
INSTALLATION PROCEDURE	1
OPERATING INSTRUCTIONS	4
POWERING UP	4
BUILDING A SYSTEM	6
SPECIFICATIONS	7
SYSTEM MAINTENANCE	8
GENERAL	8
TROUBLESHOOTING AIDS	9
TROUBLESHOOTING TECHNIQUES	9
PARTS ORDERING AND REPLACEMENT	11
OPTION INFORMATION	15
SERVICE INFORMATION	18
INTERFACE PIN ASSIGNMENTS	19
DETAILED BLOCK DIAGRAM	19
PARTS LOCATION GRID	20
ELECTRICAL PARTS LIST	21
POWER SUPPLY	21
MECHANICAL PARTS LIST	24
EXPLODED VIEW DRAWING	

# INSTALLATION PROCEDURE

## Before you start...

1. Check the rear panel markings. If the factory settings are compatible with the available line voltage and frequency, insert the desired plug-ins. Use the bail to raise the front of the instrument.

**...go to Operating Instructions...**

2. If a change is needed, follow these steps:

### a. Line Selector Block(s)

Remove the five hold-down screws on the top of the dust cover cabinet and lift the cabinet off. This gives easy access to the Line Selector blocks located on the main circuit board.

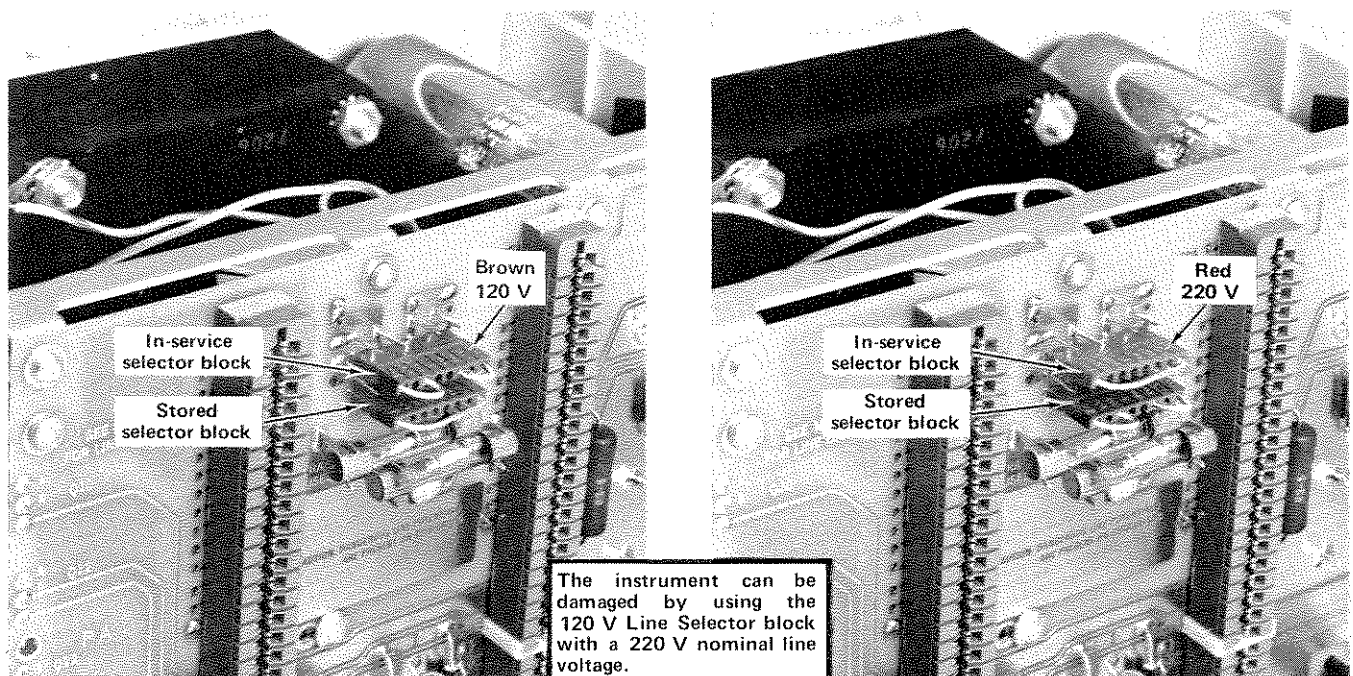

**b. Line Range Taps**

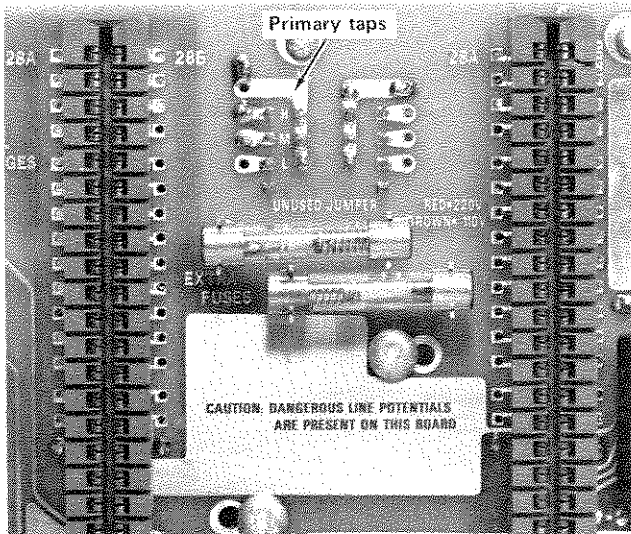

**Universal Transformer (SN BO50000 - up)**

Line Selector Block Position	Regulating Ranges	
	120-Volts Nominal	220-Volts Nominal
L	90 VAC to 110 VAC	180 VAC to 220 VAC
M	99 VAC to 121 VAC	198 VAC to 242 VAC
H	108 VAC to 132 VAC	216 VAC to 264 VAC
Line Fuse Data	1.6 A slow-blow	0.8 A slow-blow

**Standard Transformer (SN BO50000 - below)**

Line Selector Block Position	Regulating Ranges
L Do not use	Internally Disconnected
M (110 V Nominal)	99 VAC to 121 VAC
H (120 V Nominal)	108 VAC to 132 VAC

**c. Rear Panel**

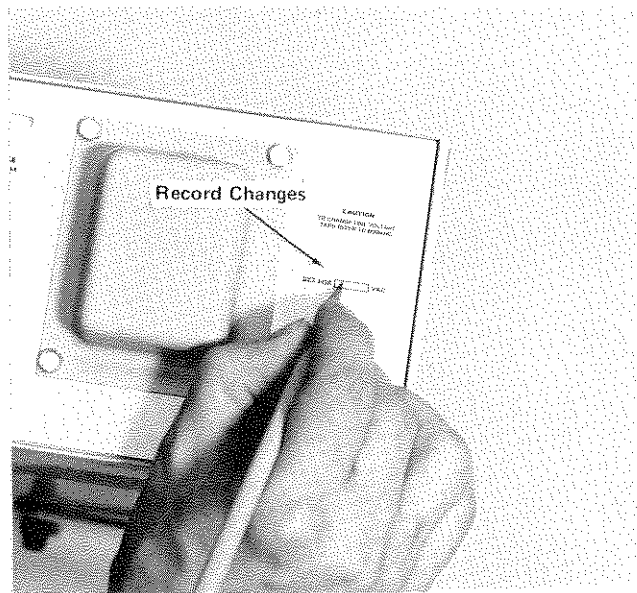
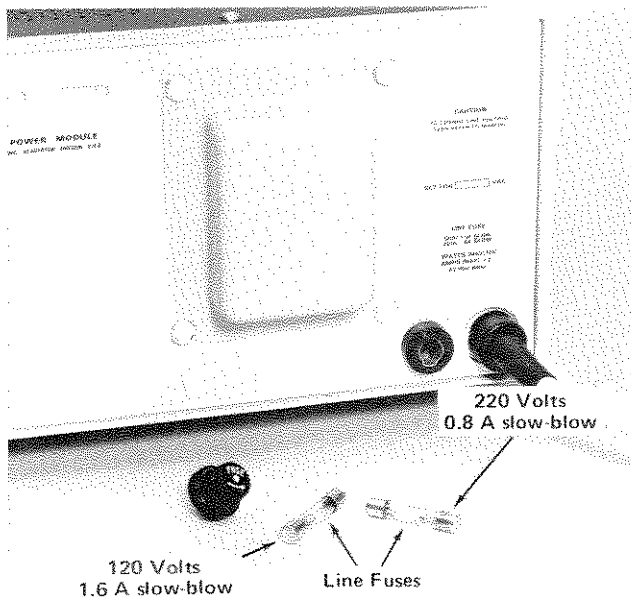

3. Replace the cabinet.
4. If necessary, change the line cord power plug to match the power source receptacle or use an adapter.
5. Plug the cord into the power source.
6. Insert the desired plug-ins.
7. Use the bail to raise the front of the instrument. **...go to Operating Instructions...**

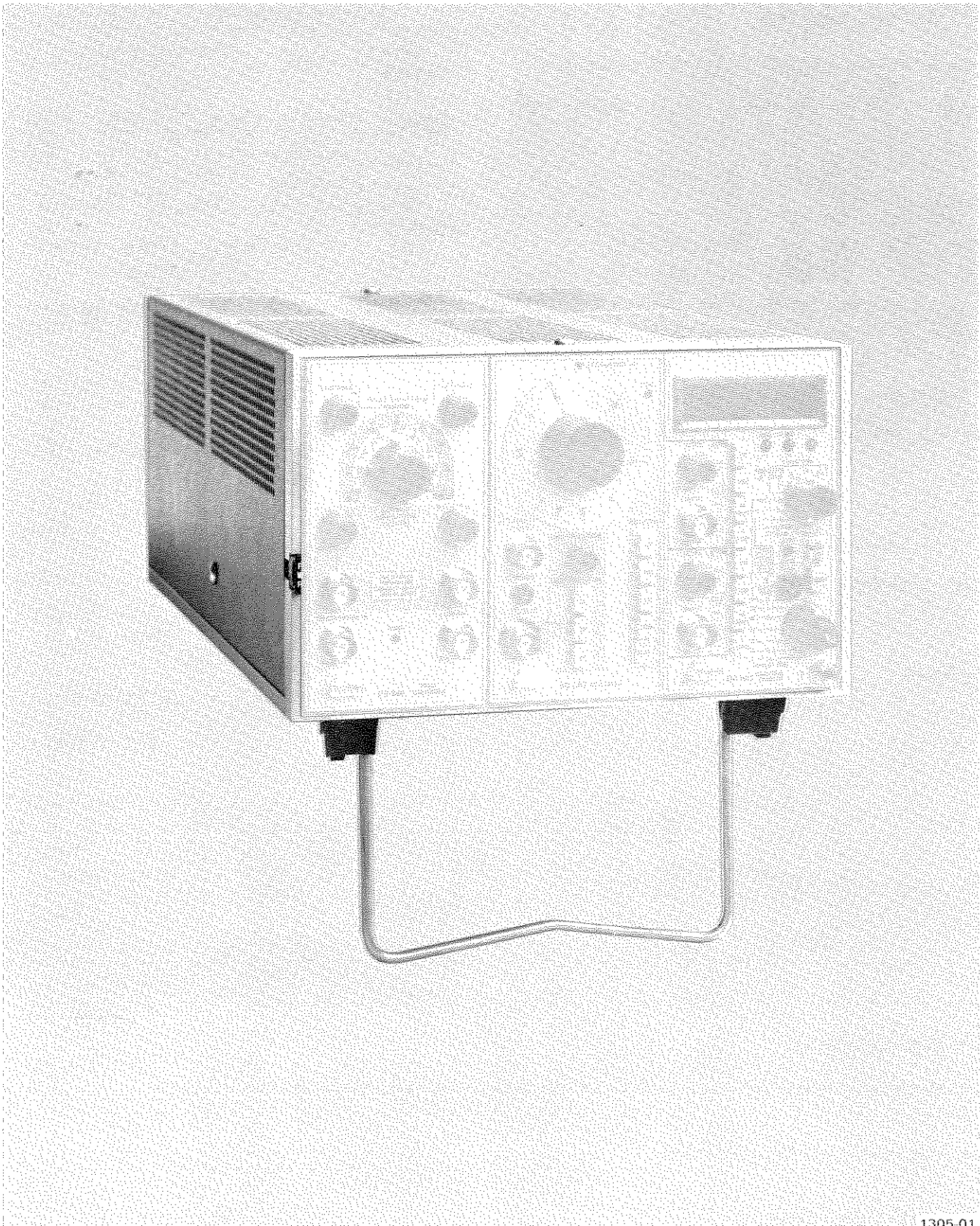

1305-01

TM 503 Power Module with plug-ins.

# TM 503 OPERATING INSTRUCTIONS

## INTRODUCTION

### Description

The TEKTRONIX TM 503 Power Module is a three-compartment-wide mainframe for the TM 500 Series of Modular Instrumentation. It accepts up to three independently functional plug-in modules to form a compact, versatile and low cost instrumentation system. The TM 503 is a basic power source and provides an interconnecting scheme for the other members of the TM 500 Series family. Factory options allow customer modification using signal access at the plug-in module/power module interface to provide rear panel inputs and outputs, and interconnections between compartments.

### Power Source

This instrument is designed to operate from a power source with its neutral at or near earth (ground) potential with a separate safety-earth conductor. It is not intended for operation from two phases of a multi-phase system, or across the legs of a single-phase, three-wire system.

### Power Usage

With three plug-in modules installed, the TM 503 can require up to 120 W of power at the upper limits of the high line voltage ranges. Actual power consumption depends on the particular module combination and operating mode selected at any one time.

### Operating Temperatures

The TM 503 can be operated in an ambient air temperature of 0°C to +50°C. Thermal cutout devices protect the system by disconnecting the power to the TM 503 Power Module when internal temperatures rise above a safe operating level. These devices automatically return power to the unit when the internal temperatures return to a safe level.

Since the TM 503 can be stored in temperatures between -40°C and +75°C, allow the instrument's chassis to return to within the operating limits before applying power.

## POWERING UP

### Plug-in Modules

It is not necessary that all the plug-in compartments be utilized in order to operate the Power Module. The only modules needed are those necessary to accomplish the task.

#### CAUTION

*Turn the Power Module off before inserting the plug-in; otherwise, damage may occur to the plug-in circuitry.*

### Module Installation

1. Check the location of the white plastic barriers on the interconnecting jack to insure that their locations match the slots in the edge of the plug-in module's circuit board.

2. Align the plug-in module chassis with the upper and lower guides of the selected compartment. Push the module in and press firmly to seat the circuit board in the interconnecting jack. (Remove the plug-in module by pulling on the white release latch located in the lower left corner of each module.)

3. Pull the PWR button on the left side of the TM 503. Some plug-in modules have independent power switches, usually labeled OUTPUT, controlling application of mainframe power to the module itself. Push this button to activate the plug-in module.

### Loading Considerations

With three plug-in modules installed, the TM 503 can require up to 120 W of power from the line at high-line

## Operating Instructions—TM 503

voltage range settings. Actual power consumed, of course, depends on the particular module combination selected at any one time.

This power capability can best be utilized by carefully planning the functional combinations of plug-ins, their external loads, and the resulting power distributions. Optimum conditions would be (1) equal loads in all three compartments, (2) as much power as possible dissipated in

external loads, and (3) operating in an ambient temperature around +25°C.

The TM 503 provides each plug-in module with access to a pair of heat-sinked, chassis-mounted transistors, one NPN and one PNP. These Series-Pass transistors allow the plug-in modules to operate in power ranges not possible if the power had to be dissipated in the modules themselves.



# BUILDING A SYSTEM

## Family Compatibility

Mechanically, the plug-in modules are very similar to other TEKTRONIX product families. However, they are not **electrically** compatible. Therefore, the TM 503 interface has barriers on the mating connectors between pins 6 and 7 to insure that incompatible plug-ins cannot be inserted. See Figure 1. A compatible module will have a matching slot between pins 6 and 7 of its main circuit board edge connector. This slot and barrier combination is the primary keying assignment.

Another identifier for TM 500-compatible plug-in modules is the white color of the release latch.

## Customizing the Interface

The modularity of this instrumentation system provides for a host of functions to be performed by the plug-in modules. Specific functions are grouped into families or classes, of which there may be several plug-in module

members. For instance, some classes are Power Supplies, Signal Sources, Measurement and so forth. Each modular member of a functional family will have a second slot peculiar to its family assignment located in its edge connector. The TM 503 user can "program" one or more compartments to accept only members of that family by installing a second barrier in the interface connector to match the module's slot location. Entire TM 503's could be "programmed" in this manner to set up instrumentation systems for specific work functions. For extra barriers, order TEKTRONIX Part Number 214-1593-02.

Jumper wires can be used to further specialize the interface. Compartments can be made to "talk" to each other by connecting jumpers on the back side of the interface board, using pins 14 through 28, A-side and B-side both, of the interconnecting jacks. See the following description of catalog Option 2. Refer to each plug-in module's Manual for the I/O assignments of each pin at the rear interface. Once having made interconnections of a specialized nature, it is recommended that barriers be installed on the interconnecting jacks to insure module compatibility with the customized wiring.

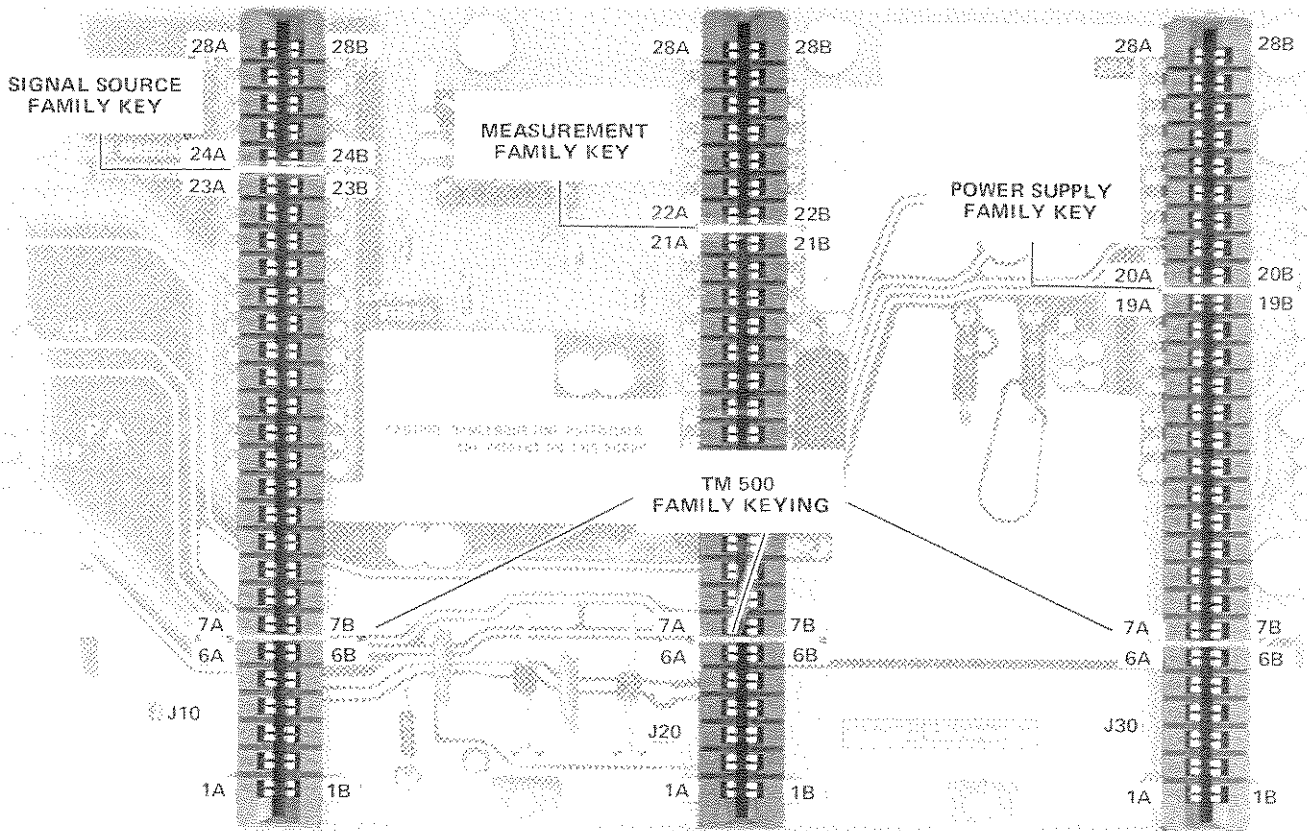

Figure 1. Keying assignments for family functions. One of many possible sequence combinations.

**Rear Panel**

The rear sub-panel is punched for BNC and multi-pin connector mountings. Customer- or factory-installed connectors and wiring (see following description of catalog Option 2) could provide external access to the interface for external I/O control. This feature makes the TM 500 Series Modular Instrumentation System very flexible in bench-top or rackmounted systems.

**Option 2.** This factory-installed option adds 25-mil squarepin connectors to the rear of the interconnecting jacks at all pin locations from pins 14A and B through pins 28A and B. This will keep the interface flexible by making it easy and fast to change customized wiring using prepared wires with squarepin receptacles and long-nose pliers or tweezers. It also protects the circuit board from damage by repeated soldering and unsoldering of jumper wires. This option also adds three BNC connectors and one 50-pin connector to the rear panel. These connectors are not pre-wired in order to give a system designer as much flexibility as possible. Instead, prepared jumpers, coax cables, and interconnection jack barriers are included in a kit.

**Stacking and Rackmounting**

TM 503's with their cabinets and feet in place may be stacked on top of each other. The feet provide clearance for the lower unit's handle and at the same time give adequate spacing for the necessary ventilation.

The TM 503 is designed to be half-rack width. Field conversion kits with slide-out tracks are available to mount one or two TM 503's in a standard 19-inch rack. Vertical space needed is 5 1/4 inches.

For the necessary hardware and instructions to mount two TM 503's side-by-side with slide-out assemblies, order TEKTRONIX Part Number 040-0616-01.

To mount a single TM 503 with a half-rack assembly and slide-out tracks, order TEKTRONIX Part Number 040-0617-01.

To convert from a rackmount to a bench configuration for a single TM 503, order TEKTRONIX Part Number 040-0618-01.

**SPECIFICATIONS**

**Power Requirements**

**Line Voltage Ranges.** Universal Transformer: 100, 110, 120, 200, 220, 240 VAC, all within 10%. Range changing for transformer accomplished with quick-change line-selector block.

**Line Frequency Ranges.** Universal Transformer: 48 Hz to 440 Hz.

**Power Consumption.** Maximum primary power approximately 120 W at high line. Actual power consumption depends on plug-in selection and operating modes.

+33.5 V and -33.5 V, 1 A maximum each supply, shared by all compartments. *23.7 to 40.0 34A*

17.5 VAC and +11.5 V, 3.6 A maximum, shared in any combination between these two supplies and shared among all compartments.

*11.5 = 7.6 to 16V = 3.2A  
17.5V = 11.0% - 20% = NOTE 5.0*

*Current and voltage ratings are for main frame maintenance only. In practice, not all available power may be used at once. More detailed information is supplied with kit 040-0652-02 (TM 500-plug-in).*

**Power Cord Conductor Identification**

Conductor	Color	Alternate Color
Ungrounded (Line)	Brown	Black
Grounded (Neutral)	Blue	White
Grounding (Earthing)	Green-Yellow	Green-Yellow

**Temperature Range**

Operating: 0°C to +50°C. Nonoperating: -40°C to +75°C.

**Altitude Range**

Operating: To 15,000 feet. Nonoperating: To 50,000 feet.

**Other**

Dimensions with Feet and Bail: H 6.0 in., W 8.7 in., L 15.3 in.

Weight without Plug-ins: Approximately 9.5 lb.

**Supplies (Unregulated)**

Two 25 VAC windings, 500 mA each, supplied to each compartment, independently. *+10% -15% 50A*

# TM 503 SYSTEM MAINTENANCE

## GENERAL

### Introduction

This section of the manual is meant to support the entire TM 500 Series family of modules with a general coverage of the most commonly-needed service information pertinent to preventive maintenance, troubleshooting, ordering parts, and replacing components and sub-assemblies.

### Cabinet Removal

#### **WARNING**

*Dangerous potentials exist at several points throughout the system. When the system must be operated with the cabinet removed, do not touch exposed connections or components. Some transistors have voltages present on their cases. Disconnect power before cleaning the system or replacing parts.*

Two screws on the top secure the cabinet to the TM 503 frame. Remove them and lift the cabinet straight up. Do not operate the system with the cabinet removed any longer than necessary for troubleshooting and calibration. Re-install the cabinet to protect the interior from dust and to remove personnel shock hazards.

### Cleaning

#### **CAUTION**

*Avoid using chemical cleaning agents which might damage plastic parts. Avoid chemicals containing benzene, toluene, zylene, acetone, or similar solvents.*

**Exterior.** Loose dust may be removed with a soft cloth or a dry brush. Water and a mild detergent may be used; however, abrasive cleaners should not be used.

**Interior.** Cleaning the interior of a unit should precede calibration since the cleaning processes could alter the settings of calibration adjustments. Use low-velocity compressed air to blow off accumulated dust. Hardened dirt can be removed with a soft, dry brush, cotton-tipped swab, or a cloth dampened in a solution of water and mild detergent.

### Preventive Maintenance

Preventive maintenance steps performed on a regular basis will enhance the reliability of the instrumentation system. However, periodic checks of the semiconductors in the absence of a malfunction are not recommended as preventive maintenance measures. See the semiconductor checking information under Troubleshooting Techniques which follow. A convenient time to perform preventive maintenance is just before instrument calibration.

### Calibration

To insure accurate signal generation and measurement, the performance of individual units comprising the system should be checked periodically. Refer to the Instruction Manual for each unit for complete calibration and verification procedures.

# TROUBLESHOOTING AIDS

## Introduction

The following is provided to augment information contained elsewhere in this and other TM 500 Series family manuals when troubleshooting becomes necessary.

## Circuit Descriptions

Each manual has a section devoted to explaining circuit operating theory. Used conjointly with the schematics, this can be a powerful analytic tool.

## Diagrams

Block diagrams and detailed circuit schematics are located on foldout pages in the service section of most of the TM 500 Series family manuals. The schematic diagrams show the component values and assigned circuit reference numbers of each part necessary to the circuit design. Usually the first page of the service sections defines the circuit symbols and reference designators used in that particular instrument. Major circuits are usually identifiable by a series of component numbers. Important waveforms and voltages may be shown within the diagrams or on adjoining aprons. Those portions of the circuits located on circuit boards are enclosed with a blue tint outline.

## Cam Switch Charts

Cam switches shown on the diagrams are coded on comprehensive charts to locate the cam number of the switch contact in the complete switch assembly, counting from the front, or knob end, toward the rear of the switch. The charts also indicate with a solid dot when each contact is closed.

## Circuit Board Illustrations

Line illustrations showing component locations keyed with a grid scheme for each circuit board are usually placed on the back of a foldout page and sequenced as close as possible to an associated schematic. The GRID LOC column in the Electrical Parts Lists keys each component to the Location illustrations.

## Component and Wiring Color Codes

Colored stripes or dots on electrical components signify electrical values, tolerances, etc., according to EIA standards. Components not color-coded usually have information printed on the body. The wiring coding follows the same EIA standards.

## Testing Equipment

Generally, a wide-band oscilloscope, a probe, and a multimeter are all that is needed to perform basic waveform and voltage checks for diagnostic purposes. The calibration procedures in the manual for each plug-in module list specific test equipment and the features necessary to adequately check out that particular module.

# TROUBLESHOOTING TECHNIQUES

## Introduction

This troubleshooting procedure is arranged in an order which checks the simple trouble possibilities before proceeding to extensive troubleshooting.

## Control Settings

Incorrect control settings can indicate a trouble that does not exist. If there is any question about the correct function or operation of any control, see the Operating Instructions section of the manual for the instrument involved.

## System and Associated Equipment

Before proceeding with troubleshooting the TM 500 Series system, check that the instruments in the system are operating correctly. Check for proper interconnection between the power module and the plug-in modules. Check the line voltage at the power source. Check that the signal is properly connected and that the interconnecting cables and the signal source are not defective.

The associated plug-in modules can be checked for proper operation quickly by substituting other like units

known to be operating properly. If the trouble persists after substitution, then the power module is probably at fault. Moving a properly operating plug-in from compartment to compartment will help determine if one or more compartments has a problem.

### Visual Check

Inspect the portion of the system in which the trouble is suspected. Many troubles can be located by visual clues such as unsoldered connections, broken wires, damaged circuit boards, damaged components, etc.

### Instrument Calibration

Check the calibration of the suspected plug-in module or the affected circuit if the trouble is obviously in a certain circuit. The trouble may only be a result of misadjustment or may be corrected by re-calibration. Complete calibration instructions are given in the manual for each instrument in the system.

### Circuit Isolation

Note the symptom. It often identifies the circuit in which the trouble is located. When trouble symptoms appear in more than one circuit, check the affected circuits by making waveform and voltage measurements.

Incorrect operation of all circuits often means trouble in the power supplies. Using a multimeter, check first for correct voltages of the individual regulated supplies according to the plug-in module schematics and calibration procedures. Then check the unregulated supplies of the power modules. Defective components elsewhere in the instruments can appear as power supply problems. In these instances, suspected circuits should be disconnected from apparently bad power supplies one at a time to narrow the search.

### Voltages and Waveforms

Often defective components can be located by using waveform and voltage indications when they appear on the schematic or in the calibration procedures. Such waveforms and voltage labels are typical indications and will vary between instruments. To obtain operating conditions similar to those used to take these readings, refer to the first diagram in the service sections.

### Component Checking

If a component cannot be disconnected from its circuit, then the effects of the associated circuitry must be considered when evaluating the measurement. Except for soldered in transistors and integrated circuits, most components can be lifted at one end from the circuit board.

**Transistors and IC's.** Turn the power switch off before removing or replacing any semiconductor.

A good check of transistor operation is actual performance under operating conditions. A transistor can most effectively be checked by substituting a new component for it (or one which has been checked previously). However, be sure that circuit conditions are not such that a replacement transistor might also be damaged. If substitute transistors are not available, use a dynamic tester. Static-type testers are not recommended, since they do not check operation under simulated operating conditions. A suction-type desoldering tool must be used to remove soldered-in transistors; see component replacement procedure for details.

Integrated circuits can be checked with a voltmeter, test oscilloscope, or by direct substitution. A good understanding of the circuit description is essential to troubleshooting circuits using IC's. Operating waveforms, logic levels, and other operating information for the IC's are given in the circuit description information of the appropriate manual. Use care when checking voltages and waveforms around the IC's so that adjacent leads are not shorted together. A convenient means of clipping a test probe to the 14- and 16-pin in-line IC's is with an integrated-circuit test clip. This device also doubles as an extraction tool.

**Diodes.** Do not use an ohmmeter that has a high internal current. High currents may damage the diode.

A diode may be checked for an open or shorted condition by measuring the resistance between terminals. With an ohmmeter scale having an internal source of between 800 mV and 3 V, the resistance should be very high in one direction and very low when the leads are reversed.

**Resistors.** Check the resistors with an ohmmeter. Resistor tolerances are given in the Electrical Parts List in every manual. Resistors do not normally need to be replaced unless the measured value varies widely from the specified value.

**Capacitors.** A leaky or shorted capacitor can be detected by checking resistance with an ohmmeter on the highest scale. Use an ohmmeter which will not exceed the voltage rating of the capacitor. The resistance reading should be high after initial charge of the capacitor. An open capacitor can best be detected with a capacity meter, or by checking whether it passes AC signals.

# PARTS ORDERING AND REPLACING

## Ordering

**Standard Parts.** All electrical and mechanical replacement parts can be obtained through the local TEKTRONIX Field Office or representative. However, many of the standard electronic components can be obtained locally in less time than is required to order them from Tektronix, Inc. Before purchasing or ordering replacement parts, check the Parts Lists for value, tolerance, rating, and description. When selecting replacement parts, it is important to remember that the physical size and shape of the component may affect its performance in an instrument. All replacement parts should be direct replacements unless it is known that a different component will not adversely affect the instrument performance.

**Special Parts.** Some parts are manufactured or selected by Tektronix, Inc., to satisfy particular requirements, or are manufactured for Tektronix, Inc., to our specifications. Most of the mechanical parts used in this system have been manufactured by Tektronix, Inc. Order all special parts directly from the local TEKTRONIX Field Office or representative.

**Ordering Procedure.** When ordering replacement parts from Tektronix, Inc., please include the following minimum information:

1. Instrument Type (PS 501, SG 502, DC 501, etc.)
2. Instrument Serial Number (For example, B010250)
3. A description of the part (if electrical, include the circuit number)
4. TEKTRONIX part number

Please do not return any instruments or parts before receiving directions from Tektronix, Inc.

A listing of TEKTRONIX Field Offices, Service Centers, and Representatives can be found in the TEKTRONIX Product Catalog and Supplements.

## Replacing

The exploded view drawings associated with the Mechanical Parts Lists, located to the rear of most manuals, may be especially helpful when disassembling or reassembling individual components or sub-assemblies.

**Circuit Boards.** If a circuit board is damaged beyond repair, the entire assembly including all soldered-on components, can be replaced. Part numbers are given in the mechanical parts lists for the completely wired (670 prefix) board.

To remove or replace a board, proceed as follows:

1. Disconnect all leads connected to the board (both soldered lead connections and solderless pin connections).
2. Remove all screws holding the board to the chassis or other mounting surface. Some boards may be held fast by plastic mounting clips around the board edges. For these, push the mounting clips away from the circuit board edges to free the board. Also, remove any knobs, etc., that would prevent the board from being lifted out of the instrument.
3. Lift the circuit board out of the unit. Do not force or bend the board.
4. To replace the board, reverse the order of removal. Use care when replacing pin connectors; if forced into place incorrectly positioned, the pin connectors may be damaged.

**Transistors and IC's.** Transistors and IC's should not be replaced unless they are actually defective. If removed from their sockets during routine maintenance return them to their original sockets. Unnecessary replacement or switching of semiconductor devices may affect the calibration of the instruments. When a transistor is replaced, check the operation of the part of the instrument that may be affected.

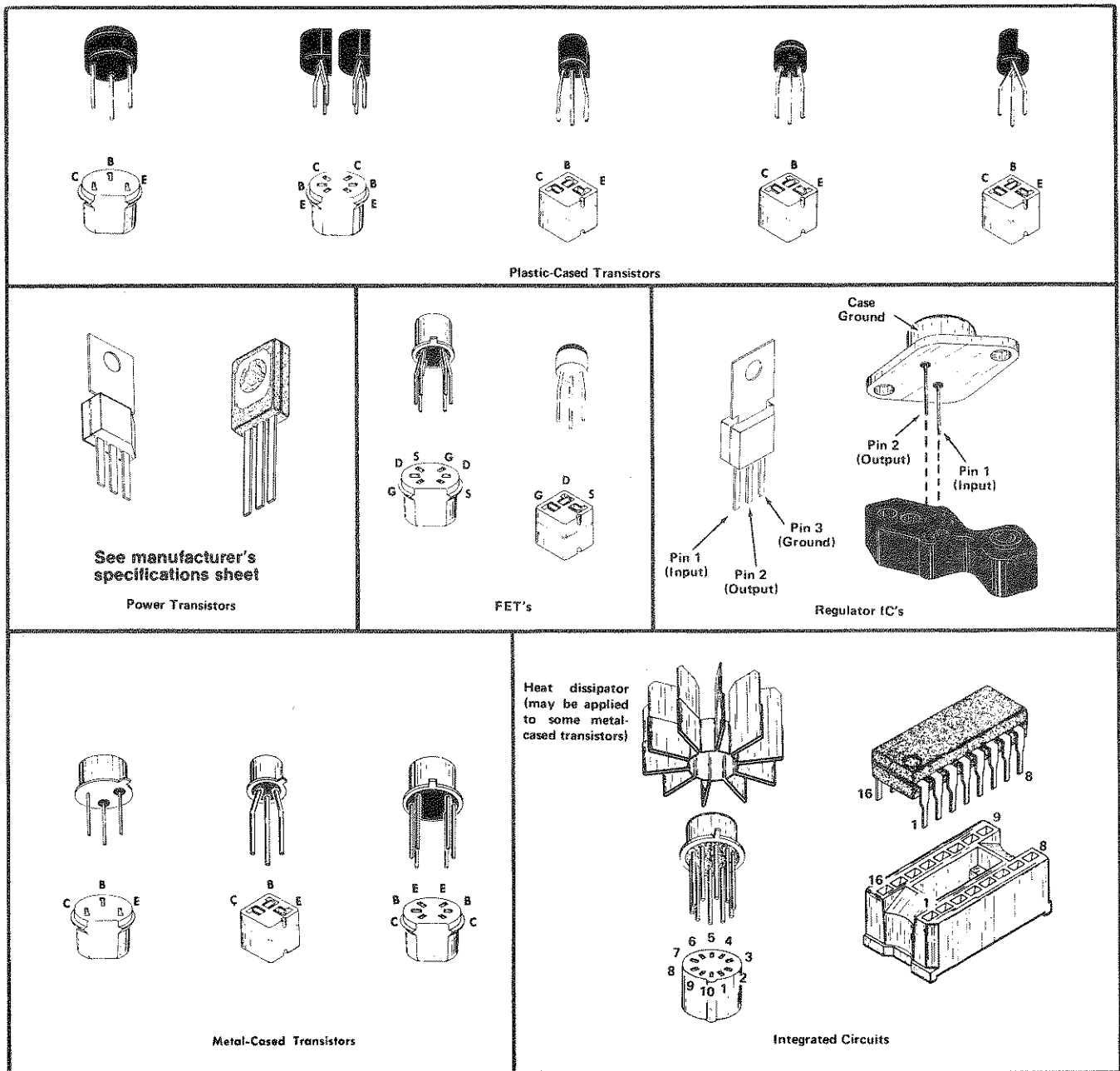

Figure 2. Semiconductor device lead configurations found in the TM 500 family.

Replacement semiconductors should be of the original type or a direct replacement. Figure 2 shows the lead configuration of the semiconductors used in this instrument system. When removing soldered-in transistors, use a suction-type de-soldering tool to remove the solder from the holes in the circuit board.

An extracting tool should be used to remove the 14- and 16-pin integrated circuits to prevent damage to the pins. This tool is available from Tektronix, Inc. Order TEKTRONIX Part No. 003-0619-00. If an extracting tool is not

available, use care to avoid damaging the pins. Pull slowly and evenly on both ends of the IC. Try to avoid having one end of the IC disengage from the socket before the other end.

To replace one of the power transistors mounted on the Power Module chassis adjacent to the interface circuit board, first unsolder the leads. Then, loosen the nuts which clamp the transistor to the chassis. Remove the defective transistor. When replacing the transistor, use a mica washer on the metal tab to increase heat transfer from the transistor to the chassis.

**Interconnecting Pins.** To replace a pin which is mounted on a circuit board, first disconnect any pin connectors. Then, unsolder the damaged pin and pull it out of the board with a pair of pliers. Be careful not to damage the wiring on the board with too much heat. Ream out the hole in the circuit board with a 0.031-inch drill. Remove the ferrule from the new interconnecting pin and press the new pin into the hole in the circuit board. Position the pin in the same manner as the old pin. If the old pin was bent at an angle to mate with a connector, bend the new pin to match the associated pins.

**NOTE**

*A pin replacement kit including necessary tools, instructions, and replacement pins is available from Tektronix, Inc. Order TEKTRONIX Part No. 040-0542-00.*

**Cam Switches.** Repair of cam-type switches should be undertaken only by experienced maintenance personnel. Switch alignment and spring tension of the contacts must be carefully maintained for proper operation of the switch. For assistance, contact your local TEKTRONIX Field Office or representative.

**NOTE**

*A cam-type switch repair kit including necessary tools, instructions, and replacement contacts is available from Tektronix, Inc. Order TEKTRONIX Part No. 040-0541-00.*

The cam-type switches consist of rotating cam drums which are turned by front-panel knobs, and sets of spring-leaf contacts mounted on adjacent circuit boards. The contacts are actuated by lobes on the cams. These switches can be disassembled for inspection, cleaning, repair, or replacement as follows:

1. Remove the screws which hold the metal cover on the switch, and lift the cover off the switch. The switch is now open for inspection or cleaning.

2. To completely remove a switch from the circuit board, first remove any knobs or shaft extensions. Loosen the coupling at the potentiometer at the rear of the switch, and pull the long shaft out of the switch assembly.

3. Remove the screws (from the opposite side of the circuit board) which hold the cam drum to the board.

4. To remove the cam drum from the front support block, remove the retaining ring from the shaft on the front of the switch and slide the cam drum out of the support block. Be careful not to lose the small detent roller.

5. To replace defective switch contacts, follow the instructions given in the switch repair kit.

6. To re-install the switch assembly, reverse the above procedure.

**Pushbutton Switches.** The pushbutton switches are not repairable and should be replaced as a unit if defective. Use a suction-type de-soldering tool to remove solder from the circuit board when removing these switches.

**Incandescent Bulbs.** Most of these light bulbs are mounted on the sub-panel using plastic sleeve stand-offs. Unsolder the lead wires and pull the bulb out of the sleeve from the rear of the sub-panel.

**Light-Emitting Diodes.** LED's used as indicators are mounted on the sub-panels with plastic sleeve sockets similar to the incandescent bulb mountings or they are soldered directly to a sub-assembly and so mounted that they protrude through holes in the panel. In these cases, the sub-assembly must be exposed and the anode and cathode lead orientations carefully noted before unsoldering the defective LED. See Figure 3 for LED lead identifying information.

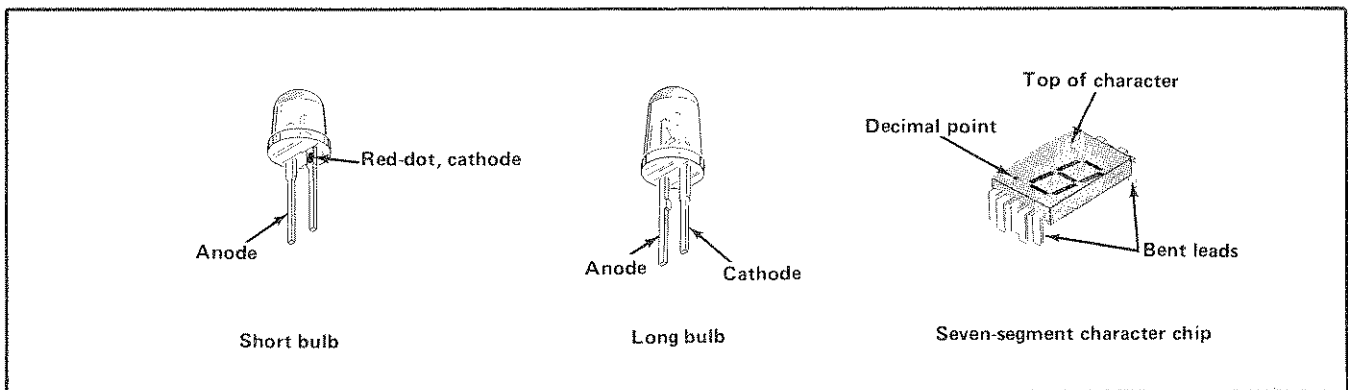

Figure 3. Light-emitting diode (LED) lead orientation illustration.



**Power Transformer.** Replace the transformer only with a TEKTRONIX direct replacement transformer. Refer to the exploded view drawing at the rear of the Power Module manuals for disassembly of the rear panel to expose the power transformer. Refer to the schematic diagram color-coding information for correct wiring. After replacement, check out the power supply voltages before installing a plug-in module.

### REPACKAGING FOR SHIPMENT

If the Tektronix instrument is to be shipped to a Tektronix Service Center for service or repair, attach a tag showing: owner (with address) and the name of an individual at your firm that can be contacted, complete instrument serial number and a description of the service required.

Save and re-use the package in which your instrument was shipped. If the original packaging is unfit for use or not available, repackage the instrument as follows:

1. Obtain a carton of corrugated cardboard having inside dimensions of no less than six inches more than the instrument dimensions; this will allow for cushioning. Refer to the following table for carton test strength requirements.
2. Surround the instrument with polyethylene sheeting to protect the finish of the instrument.
3. Cushion the instrument on all sides by tightly packing dunnage or urethane foam between carton and instrument, allowing three inches on all sides.
4. Seal carton with shipping tape or industrial stapler.

#### SHIPPING CARTON TEST STRENGTH

Gross Weight (lb)	Carton Test Strength (lb)
0-10	200
10-30	275
30-120	375
120-140	500
140-160	600



# OPTION INFORMATION

Your instrument may be equipped with one or more options. This section describes those options, or directs the reader to where the option is documented.

Option 2	Optional Interface	Described in this section	Pages 2
----------	--------------------	---------------------------	------------



## OPTION 2

### INTRODUCTION

This factory installed option adds 25-mil squarepin connectors to the rear of the interconnecting jacks at all pin locations from pins 14A and B through pins 28A and B. This will keep the interface flexible by making it easy and fast to change customized wiring using prepared wires with squarepin receptacles and long-nose pliers or tweezers. It also protects the circuit board from damage by repeated soldering and unsoldering of jumper wires. This option also adds three BNC connectors and one 50-pin connector to the rear panel. These connectors are not pre-wired in order to give a system designer as much flexibility as possible. Instead, prepared jumpers, coax cables, and interconnection jack barriers are included in the TM503.

### SYSTEM DESIGN DIRECTIONS

1. Plan the plug-in location (left, middle, or right) based on front-panel controls and operator convenience as well as interface connections.
2. Plan the wiring between interconnecting jacks and to the rear panel connectors carefully before starting assembly. A mating rear panel 50-pin connector and cover are provided for external cabling.

#### NOTE

*There are no pin assignments for the rear panel connectors, due to the great variety of possible connections.*

*When high frequency or fast digital signals are involved, plan the wires so as to minimize crosstalk. Make allowance for the possible need to make auxiliary ground connections.*

*The 50-pin rear panel connector will be easier to wire if it is removed and then reinstalled after wiring is complete. (The rear panel cutout exposes the 50-pin connector mounting hardware for ease of removal and replacement.)*

3. Pin assignments for individual plug-ins will be found in the appropriate instruction manual.
4. Install an interconnection jack barrier at the appropriate location on the interconnection jack, refer to TM503 instruction manual for keying assignments for family functions.
5. Select and install the wires (hook-up or coax) following the guidelines in the Wire Use part of these instructions.
6. Wires or cables which may be at large potential differences should be dressed or bundled so as to avoid contact. Keep all interface wiring away from the TM503 primary line wiring.

### WIRE USE

1. 5-inch long hook-up wire with squarepin receptacle on both ends (20 pieces). These may be used for low-frequency or DC circuits where impedance levels and crosstalk are not a problem. This wire length is convenient for connections between adjacent interconnecting jacks.
2. 8-inch long hook-up wire with squarepin receptacle on both ends (20 pieces). These may be used for low-frequency or DC circuits where impedance levels and crosstalk are not a problem. This wire length is convenient for connections between the left- and right-hand interconnecting jacks.
3. 9-inch long hook-up wire with a squarepin receptacle on one end only (20 pieces). These may be used for low-frequency or DC connections from any interconnecting jack to any rear panel connector. It will be necessary to cut the wire to length, then strip and tin the end of the wire to be connected to the rear panel connector.
4. 5-inch long coaxial wire with squarepin receptacles on both ends (20 pieces). These are used for connections which require shielding or which must maintain a 50 ohm characteristic impedance. The outer conductor should be connected to either chassis ground or circuit ground. Plug-in lines which require coax leads usually have a specified ground pin assignment. If necessary, establish auxiliary ground connections at the appropriate wire ends. These coaxial wires are a convenient length for connections between adjacent interconnecting jacks.
5. 9-inch long coaxial wire with squarepin receptacles on both ends (30 pieces). These coax wires are for applications such as those mentioned in item 4 above. The wire length is convenient for connections between the left- and right-hand interconnecting jacks or between any interconnecting jack and a rear panel connector. When connecting one end of the coaxial wire to a rear panel connector, it will be necessary to cut the wire to length, separate the shielding braid, then strip and tin the connector end of the wire.

MECHANICAL REPLACEABLE PARTS LIST

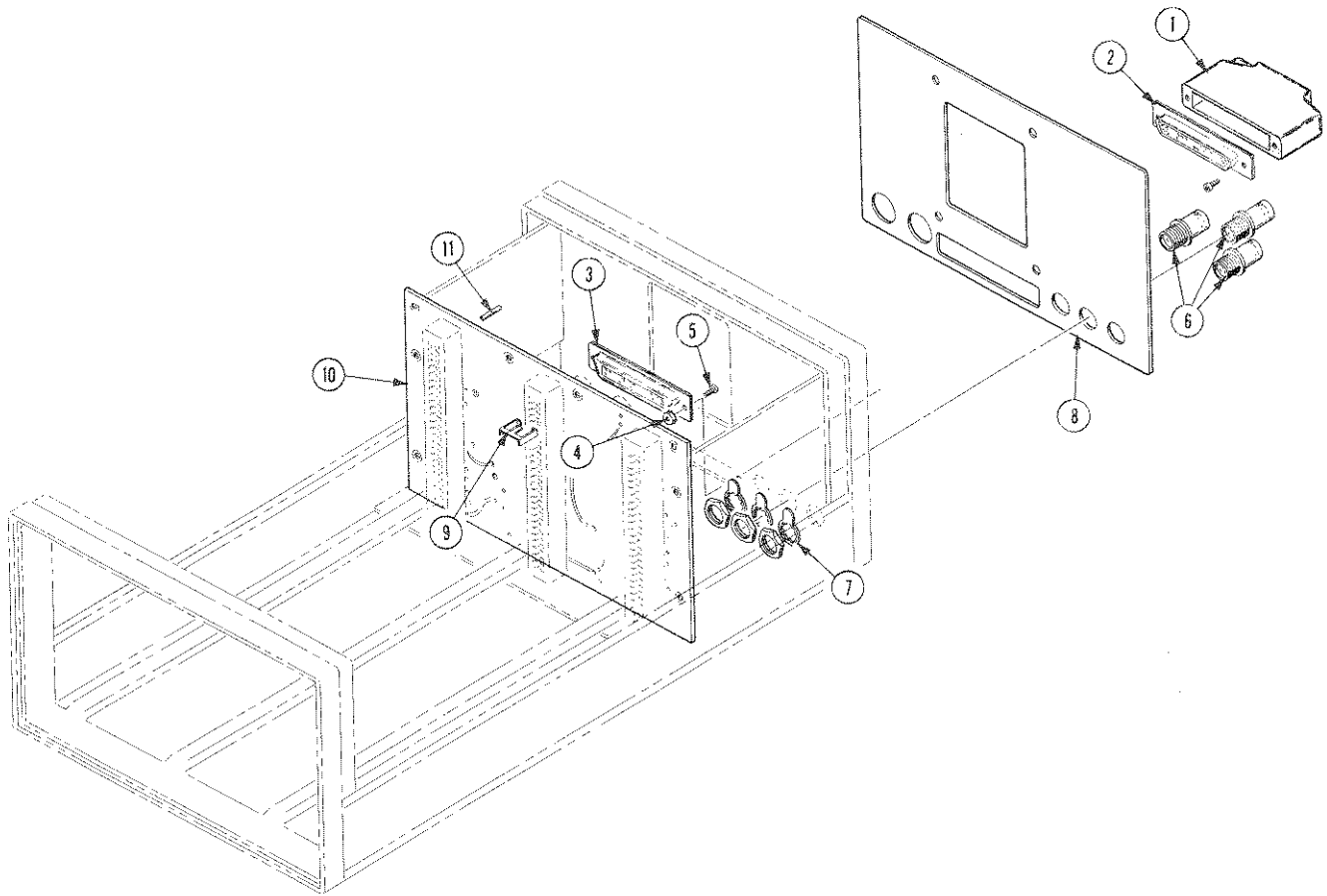

Fig. & Index No.	Tektronix Part No.	Serial/Model No. Eff	Model No. Disc	Q					Description
				Y	1	2	3	4	
3-1	131-1319-00			1					1 CONNECTOR COVER:MOLD PLASTIC (w/hardware)
-2	131-1345-00			1					1 CONN,RCPT,ELEC:50 CONT FEMALE
-3	131-1344-00			1					1 CONN,PLUG,ELEC:50 CONT MALE
	- - - - -			-					mounting hardware: (not included w/conn)
-4	210-0586-00			2					2 NUT,PLAIN,EXT W:4-40 X 0.25 INCH,STL
-5	211-0008-00			2					2 SCREW,MACHINE:4-40 X 0.25 INCH PNH,STL
-6	131-0955-00			3					3 CONN,RCPT,ELEC:BNC FEMALE (w/hardware)
	- - - - -			-					mounting hardware for each:
-7	210-0255-00			1					1 TERMINAL,LUG:0.391 ID INT TOOTH
-8	333-1701-00			1					1 PANEL,REAR:FOR TM503 OPT 2
-9	214-1593-02			15					KEY POLARIZING,CONN:
-10	670-3405-00			1					1 CKT BOARD ASSY:--OPTION 2 INTERFACE
	- - - - -			-					. circuit board assembly includes:
-11	131-0608-00			84					. TERMINAL PIN:0.365 INCH LONG
									(Other subparts same as standard interface circuit board.)
	020-0074-00			1					1 WIRE KIT:FOR TM503 OPTION 2

# DIAGRAMS AND CIRCUIT BOARD ILLUSTRATIONS

## Symbols and Reference Designators

Electrical components shown on the diagrams are in the following units unless noted otherwise:

- Capacitors = Values one or greater are in picofarads (pF).  
Values less than one are in microfarads ( $\mu$ F).
- Resistors = Ohms ( $\Omega$ ).

Graphic symbols and class designation letters are based on ANSI Standard Y32.2-1975.

Logic symbology is based on ANSI Y32.14-1973 in terms of positive logic. Logic symbols depict the logic function performed and may differ from the manufacturer's data.

The overline on a signal name indicates that the signal performs its intended function when it goes to the low state.

Abbreviations are based on ANSI Y1.1-1972.

Other ANSI standards that are used in the preparation of diagrams by Tektronix, Inc. are:

- Y14.15, 1966 Drafting Practices.
- Y14.2, 1973 Line Conventions and Lettering.
- Y10.5, 1968 Letter Symbols for Quantities Used in Electrical Science and Electrical Engineering.

The following prefix letters are used as reference designators to identify components or assemblies on the diagrams.

A	Assembly, separable or repairable (circuit board, etc)	H	Heat dissipating device (heat sink, heat radiator, etc)	S	Switch or contactor
AT	Attenuator, fixed or variable	HR	Heater	T	Transformer
B	Motor	HY	Hybrid circuit	TC	Thermocouple
BT	Battery	J	Connector, stationary portion	TP	Test point
C	Capacitor, fixed or variable	K	Relay	U	Assembly, inseparable or non-repairable (integrated circuit, etc.)
CB	Circuit breaker	L	Inductor, fixed or variable	V	Electron tube
CR	Diode, signal or rectifier	M	Meter	VR	Voltage regulator (zener diode, etc.)
DL	Delay line	P	Connector, movable portion	W	Wirestrap or cable
DS	Indicating device (lamp)	Q	Transistor or silicon-controlled rectifier	Y	Crystal
E	Spark Gap, Ferrite bead	R	Resistor, fixed or variable	Z	Phase shifter
F	Fuse	RT	Thermistor		
FL	Filter				

The following special symbols may appear on the diagrams:

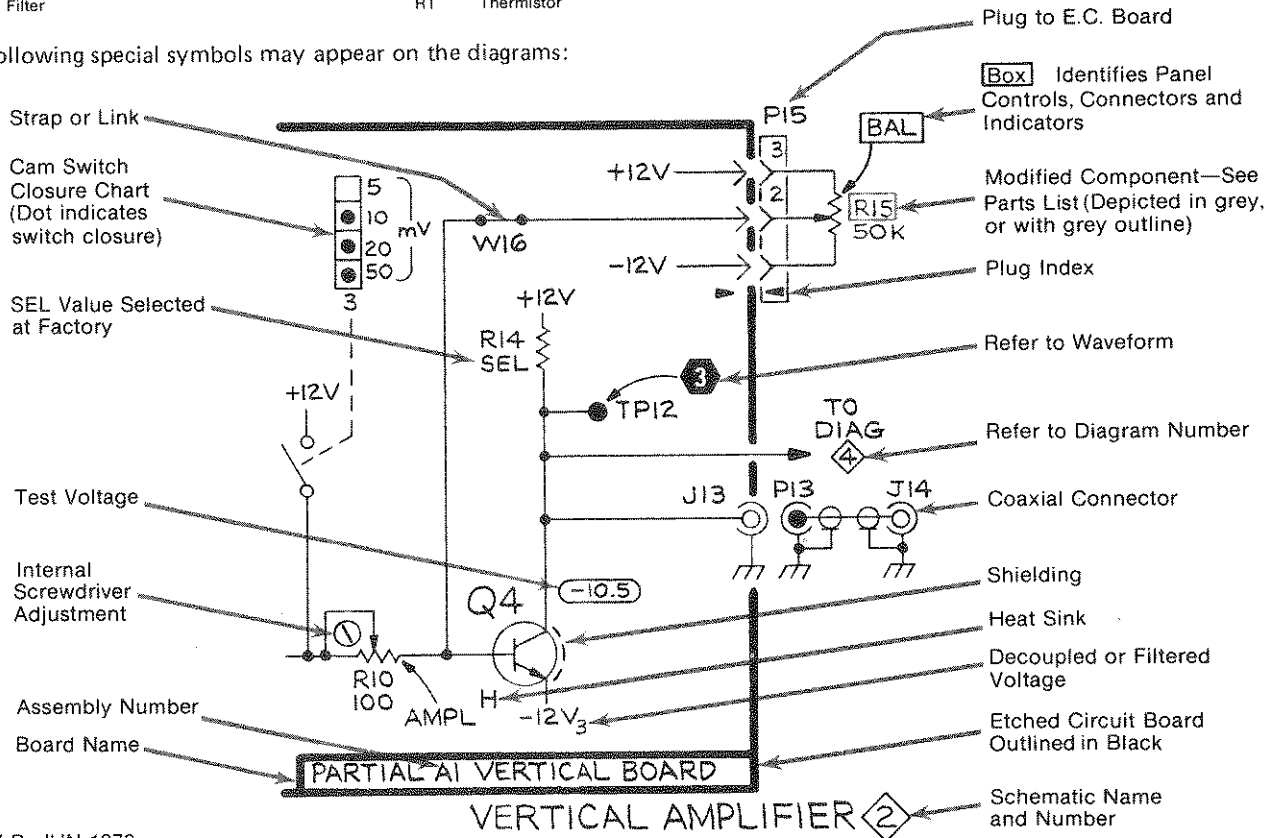

○

○

]

]

]

]

]

]

]

○

]

]



# DETAILED BLOCK DIAGRAM

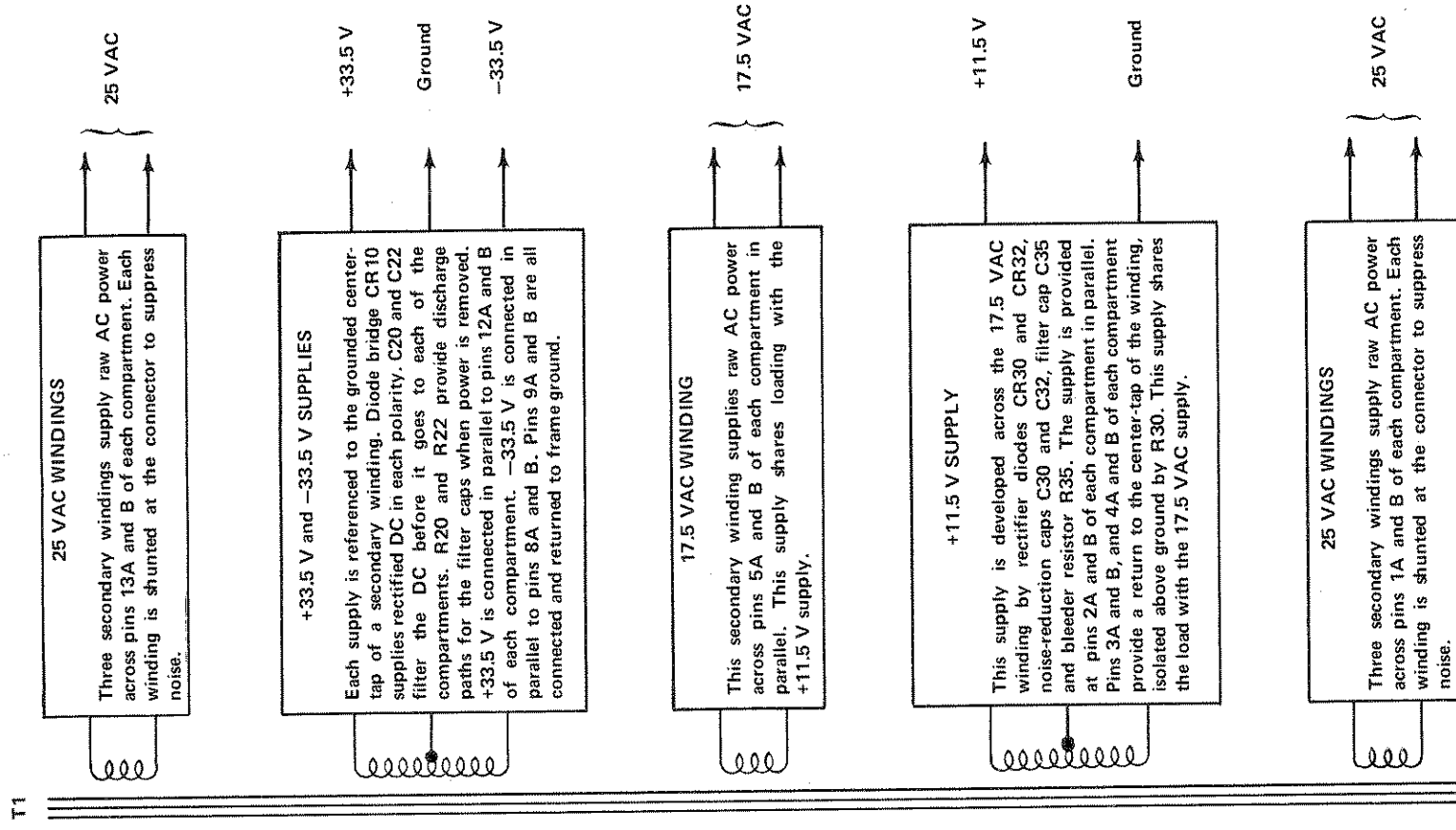

T1

**PRIMARY**  
Transformer primary power arrives via F2, S2, S3, S4, and the line-selector block P1 or P2. S3 and S4 are chassis-mounted thermal cut-outs which interrupt primary power when internal temperatures rise above a safe level. When the instrument cools, S3 and S4 will close and complete the primary circuit. C2 shunts line transients to the neutral side of the line. P1 is wired to place the primary windings in parallel for nominal 120 V line voltage operation. P2 is wired to place the primary windings in series for 220 V nominal line voltage operation.

120 V / 220 V AC

# POWER MODULE INTERFACE PIN ASSIGNMENTS FRONT VIEW

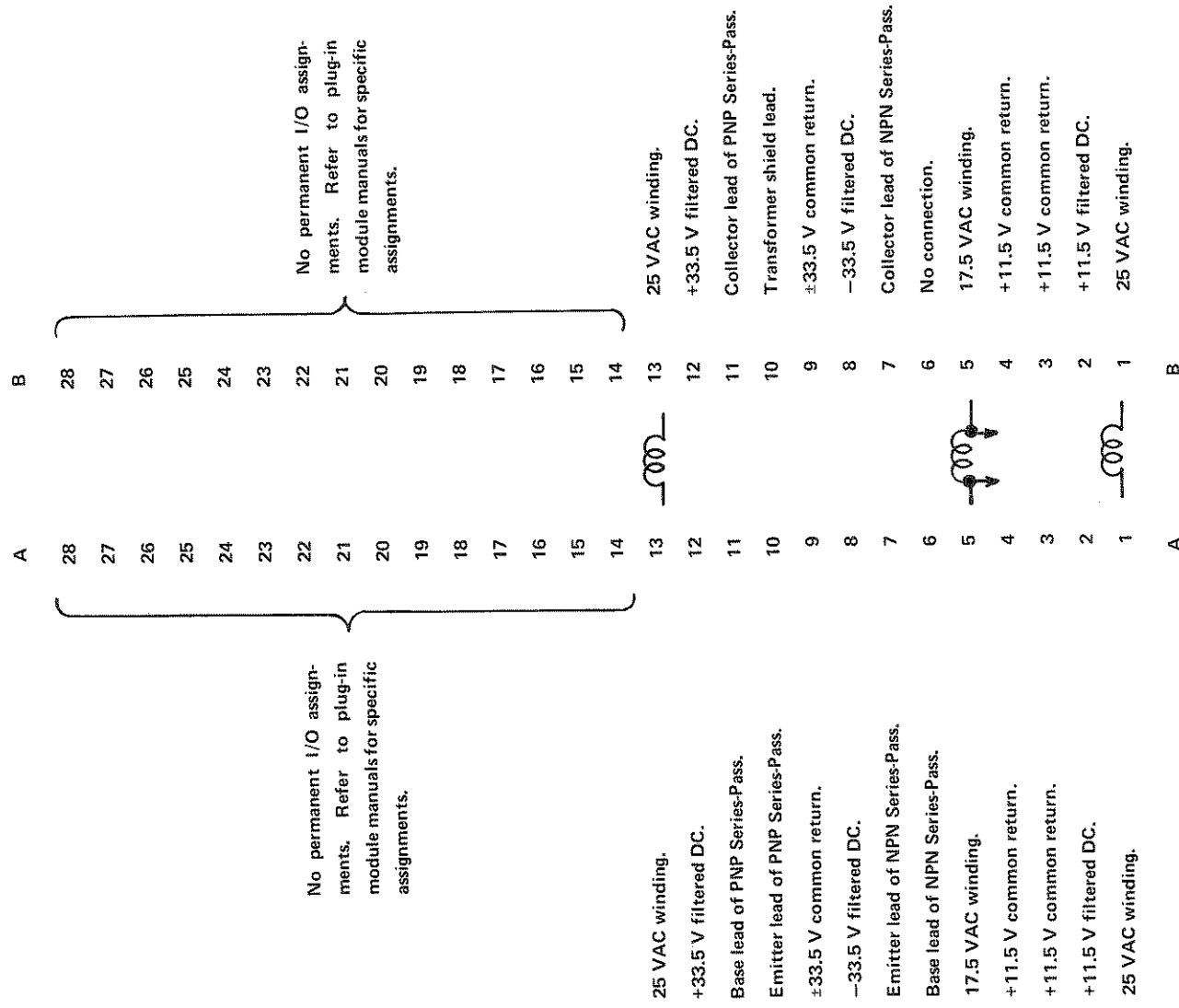

# PARTS LOCATION GRID

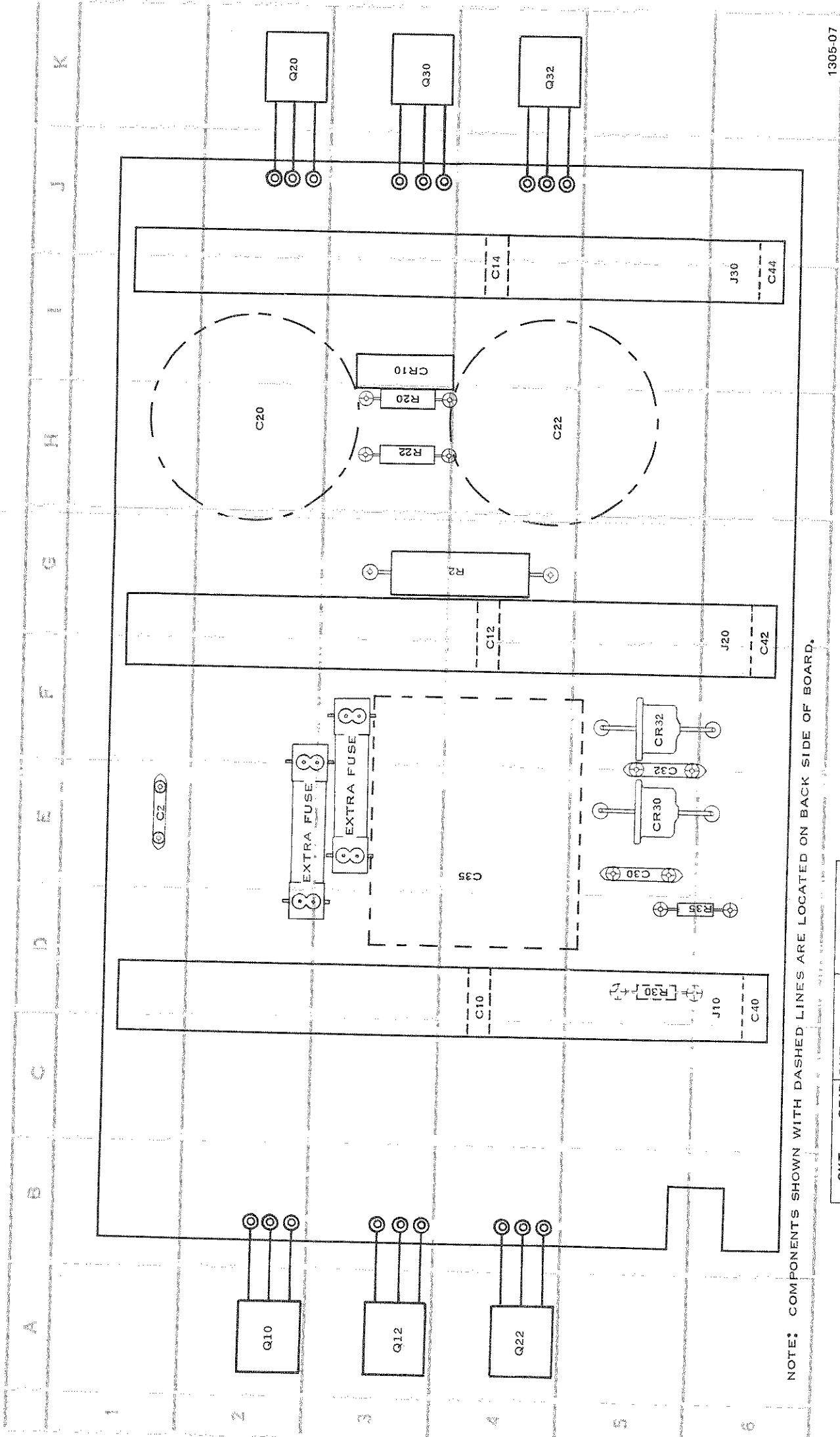

NOTE: COMPONENTS SHOWN WITH DASHED LINES ARE LOCATED ON BACK SIDE OF BOARD.

1305-07

CKT NO	GRID LOC	GRID NO	CKT NO	GRID LOC	GRID NO
C2	E1	I3	Q22	A4	A4
C10	D4	E5	Q30	K3	K3
C12	G4	F5	Q32	K4	K4
C14	I4	F5			
C20	H2		R2	G4	G4
C22	H4	D6	R20	H3	H3
C30	E5	G6	R22	H3	H3
C32	E5	I6	R30	D5	D5
C35	E4		R35	D6	D6
C40	D6	A2			
C42	F6	A3			
C44	I6	K2			

# REPLACEABLE ELECTRICAL PARTS

## PARTS ORDERING INFORMATION

Replacement parts are available from or through your local Tektronix, Inc. Field Office or representative.

Changes to Tektronix instruments are sometimes made to accommodate improved components as they become available, and to give you the benefit of the latest circuit improvements developed in our engineering department. It is therefore important, when ordering parts, to include the following information in your order: Part number, instrument type or number, serial number, and modification number if applicable.

If a part you have ordered has been replaced with a new or improved part, your local Tektronix, Inc. Field Office or representative will contact you concerning any change in part number.

Change information, if any, is located at the rear of this manual.

## SPECIAL NOTES AND SYMBOLS

X000 Part first added at this serial number

00X Part removed after this serial number

## ITEM NAME

In the Parts List, an Item Name is separated from the description by a colon (:). Because of space limitations, an Item Name may sometimes appear as incomplete. For further Item Name identification, the U.S. Federal Cataloging Handbook H6-1 can be utilized where possible.

## ABBREVIATIONS

ACTR	ACTUATOR	PLSTC	PLASTIC
ASSY	ASSEMBLY	QTZ	QUARTZ
CAP	CAPACITOR	RECP	RECEPTACLE
CER	CERAMIC	RES	RESISTOR
CKT	CIRCUIT	RF	RADIO FREQUENCY
COMP	COMPOSITION	SEL	SELECTED
CONN	CONNECTOR	SEMICOND	SEMICONDUCTOR
ELCTLT	ELECTROLYTIC	SENS	SENSITIVE
ELEC	ELECTRICAL	VAR	VARIABLE
INCAND	INCANDESCENT	WW	WIREWOUND
LED	LIGHT EMITTING DIODE	XFMR	TRANSFORMER
NONWIR	NON WIREWOUND	XTAL	CRYSTAL

CROSS INDEX—MFR. CODE NUMBER TO MANUFACTURER

Mfr. Code	Manufacturer	Address	City, State, Zip
01121	ALLEN-BRADLEY COMPANY	1201 2ND STREET SOUTH	MILWAUKEE, WI 53204
04713	MOTOROLA, INC., SEMICONDUCTOR PROD. DIV.	5005 E MCDOWELL RD, PO BOX 20923	PHOENIX, AZ 85036
14099	SEMTECH CORP.	652 MITCHELL RD.	NEWBURY PARK, CA 91320
56289	SPRAGUE ELECTRIC CO.		NORTH ADAMS, MA 01247
71400	BUSSMAN MFG., DIVISION OF MCGRAW-EDISON CO.	2536 W. UNIVERSITY ST.	ST. LOUIS, MO 63107
72982	ERIE TECHNOLOGICAL PRODUCTS, INC.	644 W. 12TH ST.	ERIE, PA 16512
80009	TEKTRONIX, INC.	P O BOX 500	BEAVERTON, OR 97077
81439	THERM-O-DISC, INC.	1320 S MAIN, P O BOX 1538	MANSFIELD, OH 44907
90201	MALLORY CAPACITOR CO., DIV. OF P. R. MALLORY AND CO., INC.	3029 E. WASHINGTON STREET P. O. BOX 372	INDIANAPOLIS, IN 46206
91637	DALE ELECTRONICS, INC.	P. O. BOX 609	COLUMBUS, NE 68601
91929	HONEYWELL, INC., MICRO SWITCH DIV.	CHICAGO & SPRING STS.	FREEPORT, IL 61032
95238	CONTINENTAL CONNECTOR CORP.	34-63 56TH ST.	WOODSIDE, NY 11377

Ckt No.	Tektronix Part No.	Serial/Model No. Eff	Dscont	Name & Description	Mfr Code	Mfr Part Number
A1	670-2024-00			CKT BOARD ASSY: INTERFACE (STANDARD AND OPTION 7 ONLY)	80009	670-2024-00
A1	670-3405-00			CKT BOARD ASSY: INTERFACE (OPTION 2 ONLY)	80009	670-3405-00
C2	283-0022-00			CAP., FXD, CER DI:0.02UF, 1400VDCAC	80009	283-0022-00
C10	283-0004-00			CAP., FXD, CER DI:0.02UF, +80-20%, 150V	72982	855-558-Z5V0203Z
C12	283-0004-00			CAP., FXD, CER DI:0.02UF, +80-20%, 150V	72982	855-558-Z5V0203Z
C14	283-0004-00			CAP., FXD, CER DI:0.02UF, +80-20%, 150V	72982	855-558-Z5V0203Z
C20	290-0520-00			CAP., FXD, ELCTLT:4500UF, +100-0%, 40V	56289	68D10474
C22	290-0520-00			CAP., FXD, ELCTLT:4500UF, +100-0%, 40V	56289	68D10474
C30	283-0002-00			CAP., FXD, CER DI:0.01UF, +80-20%, 500V	72982	811-546E103Z
C32	283-0002-00			CAP., FXD, CER DI:0.01UF, +80-20%, 500V	72982	811-546E103Z
C35	290-0321-00	B010100	B113569	CAP., FXD, ELCTLT:11000UF, +100-10%, 15V (STANDARD AND OPTION 7 ONLY)	90201	20-24012
C35	290-0508-00	B113670		CAP., FXD, ELCTLT:18,000UF, +100-10%, 15V (STANDARD AND OPTION 7 ONLY)	56289	68D10444
C35	290-0321-00	B010100	B113719	CAP., FXD, ELCTLT:11000UF, +100-10%, 15V (OPTION 2 ONLY)	90201	20-24012
C35	290-0508-00	B113720		CAP., FXD, ELCTLT:18,000UF, +100-10%, 15V (OPTION 2 ONLY)	56289	68D10444
C40	283-0004-00			CAP., FXD, CER DI:0.02UF, +80-20%, 150V	72982	855-558-Z5V0203Z
C42	283-0004-00			CAP., FXD, CER DI:0.02UF, +80-20%, 150V	72982	855-558-Z5V0203Z
C44	283-0004-00			CAP., FXD, CER DI:0.02UF, +80-20%, 150V	72982	855-558-Z5V0203Z
CR10	152-0488-00			SEMICONV DEVICE: SILICON, 200V, 1500MA	80009	152-0488-00
CR30	152-0198-00	B010100	B059999	SEMICONV DEVICE: SILICON, 200V, 3A	04713	1N4721
CR30	152-0198-02	B060000		SEMICONV DEVICE: SILICON, 200V, 3A	14099	3SM2
CR32	152-0198-00	B010100	B059999	SEMICONV DEVICE: SILICON, 200V, 3A	04713	1N4721
CR32	152-0198-02	B060000		SEMICONV DEVICE: SILICON, 200V, 3A	14099	3SM2
F2	159-0003-00			FUSE, CARTRIDGE: 3AG, 1.6A, 250V, SLOW-BLOW (FOR 120 VOLT OPERATION)	71400	MDX16-10
F2	159-0018-00			FUSE, CARTRIDGE: 3AG, 0.8A, 250V, SLOW-BLOW (FOR 220 VOLT OPERATION)	71400	MDL 8/10
J10	131-1078-00			CONNECTOR, RCPT.: 28/56 CONTACT	95238	600-1156Y256DF30
J20	131-1078-00			CONNECTOR, RCPT.: 28/56 CONTACT	95238	600-1156Y256DF30
J30	131-1078-00			CONNECTOR, RCPT.: 28/56 CONTACT	95238	600-1156Y256DF30
Q10	151-0373-00			TRANSISTOR: SILICON, PNP	80009	151-0373-00
Q12	151-0349-00			TRANSISTOR: SILICON, NPN, SEL FROM MJE2801	80009	151-0349-00
Q20	151-0373-00			TRANSISTOR: SILICON, PNP	80009	151-0373-00
Q22	151-0349-00			TRANSISTOR: SILICON, NPN, SEL FROM MJE2801	80009	151-0349-00
Q30	151-0373-00			TRANSISTOR: SILICON, PNP	80009	151-0373-00
Q32	151-0349-00			TRANSISTOR: SILICON, NPN, SEL FROM MJE2801	80009	151-0349-00
R2	308-0704-00			RES., FXD, WW: 8.8 OHM, 5%, 5W	91637	CW5-8R800J
R20	301-0202-00			RES., FXD, CMPSN: 2K OHM, 5%, 0.50W	01121	EB2025
R22	301-0202-00			RES., FXD, CMPSN: 2K OHM, 5%, 0.50W	01121	EB2025
R30	302-0102-00			RES., FXD, CMPSN: 1K OHM, 10%, 0.50W	01121	EB1021
R35	315-0511-00			RES., FXD, CMPSN: 510 OHM, 5%, 0.25W	01121	CB5115
S2	260-1222-00			SWITCH, PUSH-PUL: 10A, 250VAC	91929	2DM301
S3	260-0551-00			SW, THERMOSTATIC: NC, 10A, 240VAC	81439	S636336T21
S4	260-0551-00			SW, THERMOSTATIC: NC, 10A, 240VAC	81439	S636336T21
T1	120-0792-00	B010100	B039999	XFMR, PWR, STPDN:	80009	120-0792-00
T1	120-0793-00	B040000		XFMR, PWR, STPDN:	80009	120-0793-00

○

○

○

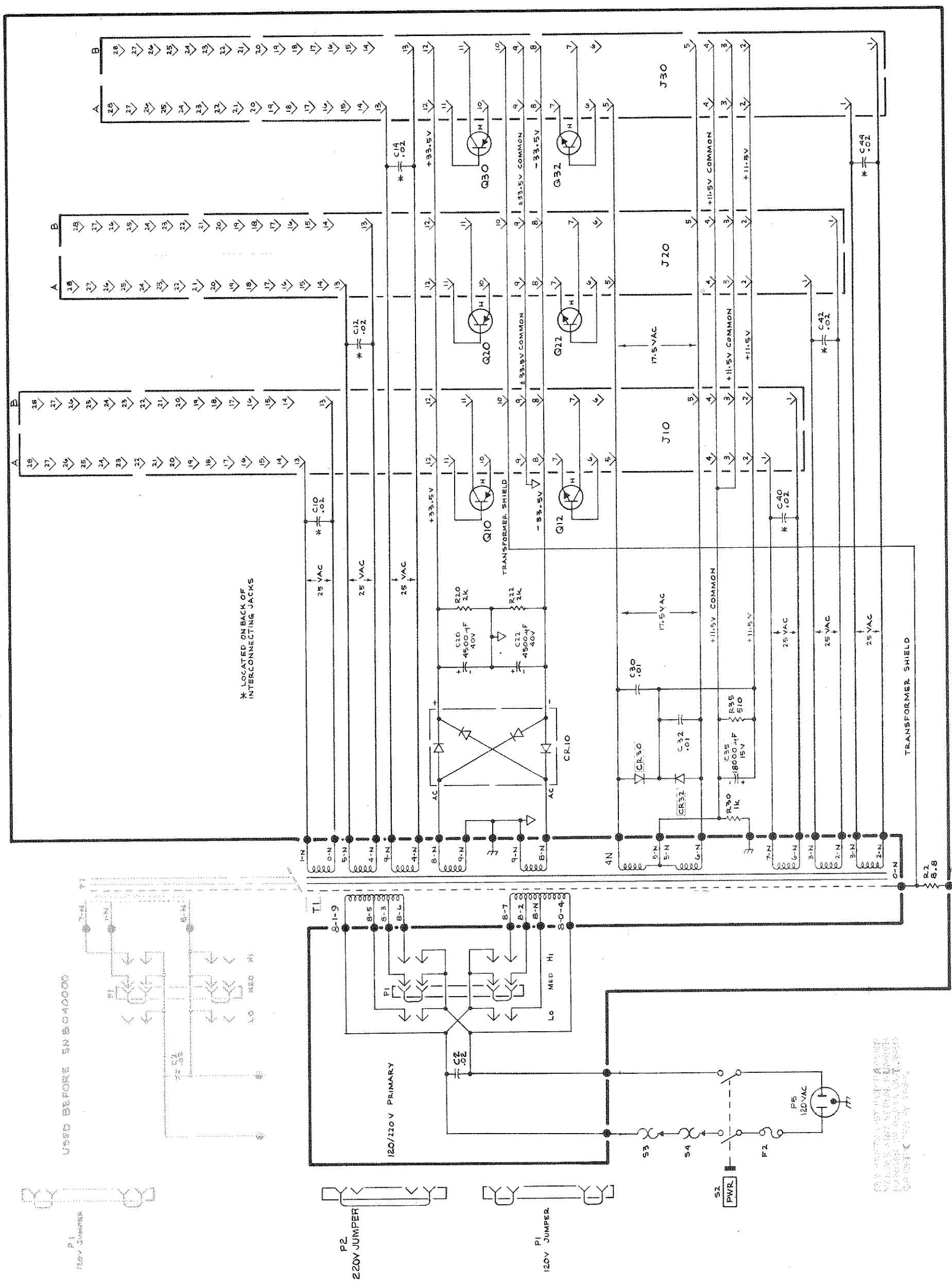

\* LOCATED ON BACK OF INTERCONNECTING JACKS

USED BEFORE SN 8040000

DO NOT REMOVE THIS LABEL FROM THE POWER SUPPLY. IT CONTAINS IMPORTANT SAFETY INFORMATION.





# REPLACEABLE MECHANICAL PARTS

## PARTS ORDERING INFORMATION

Replacement parts are available from or through your local Tektronix, Inc. Field Office or representative.

Changes to Tektronix instruments are sometimes made to accommodate improved components as they become available, and to give you the benefit of the latest circuit improvements developed in our engineering department. It is therefore important, when ordering parts, to include the following information in your order: Part number, instrument type or number, serial number, and modification number if applicable.

If a part you have ordered has been replaced with a new or improved part, your local Tektronix, Inc. Field Office or representative will contact you concerning any change in part number.

Change information, if any, is located at the rear of this manual.

## SPECIAL NOTES AND SYMBOLS

- X000 Part first added at this serial number
- 00X Part removed after this serial number

## FIGURE AND INDEX NUMBERS

Items in this section are referenced by figure and index numbers to the illustrations.

## INDENTATION SYSTEM

This mechanical parts list is indented to indicate item relationships. Following is an example of the indentation system used in the description column.

```

1 2 3 4 5           Name & Description
Assembly and/or Component
Attaching parts for Assembly and/or Component
    ---*---
Detail Part of Assembly and/or Component
Attaching parts for Detail Part
    ---*---
Parts of Detail Part
Attaching parts for Parts of Detail Part
    ---*---
    
```

Attaching Parts always appear in the same indentation as the item it mounts, while the detail parts are indented to the right. Indented items are part of, and included with, the next higher indentation. The separation symbol ---\*--- indicates the end of attaching parts.

**Attaching parts must be purchased separately, unless otherwise specified.**

## ITEM NAME

In the Parts List, an Item Name is separated from the description by a colon (:). Because of space limitations, an Item Name may sometimes appear as incomplete. For further Item Name identification, the U.S. Federal Cataloging Handbook H6-1 can be utilized where possible.

## ABBREVIATIONS

"	INCH	ELCTRN	ELECTRON	IN	INCH	SE	SINGLE END
#	NUMBER SIZE	ELEC	ELECTRICAL	INCAND	INCANDESCENT	SECT	SECTION
ACTR	ACTUATOR	ELCTLT	ELECTROLYTIC	INSUL	INSULATOR	SEMICOND	SEMICONDUCTOR
ADPTR	ADAPTER	ELEM	ELEMENT	INTL	INTERNAL	SHLD	SHIELD
ALIGN	ALIGNMENT	EPL	ELECTRICAL PARTS LIST	LPHLDR	LAMPHOLDER	SHLDR	SHOULDERED
AL	ALUMINUM	EQPT	EQUIPMENT	MACH	MACHINE	SKT	SOCKET
ASSEM	ASSEMBLED	EXT	EXTERNAL	MECH	MECHANICAL	SL	SLIDE
ASSY	ASSEMBLY	FIL	FILLISTER HEAD	MTG	MOUNTING	SLFLKG	SELF-LOCKING
ATTEN	ATTENUATOR	FLEX	FLEXIBLE	NIP	NIPPLE	SLVG	SLEEVEING
AWG	AMERICAN WIRE GAGE	FLH	FLAT HEAD	NON WIRE	NOT WIRE WOUND	SPR	SPRING
BD	BOARD	FLTR	FILTER	OBD	ORDER BY DESCRIPTION	SQ	SQUARE
BRKT	BRACKET	FR	FRAME or FRONT	OD	OUTSIDE DIAMETER	SST	STAINLESS STEEL
BR	BRASS	FSTNR	FASTENER	OVH	OVAL HEAD	STL	STEEL
BRZ	BRONZE	FT	FOOT	PH BRZ	PHOSPHOR BRONZE	SW	SWITCH
BSHG	BUSHING	FXD	FIXED	PL	PLAIN or PLATE	T	TUBE
CAB	CABINET	GSKT	GASKET	PLSTC	PLASTIC	TERM	TERMINAL
CAP	CAPACITOR	HDL	HANDLE	PN	PART NUMBER	THD	THREAD
CER	CERAMIC	HEX	HEXAGON	PNH	PAN HEAD	THK	THICK
CHAS	CHASSIS	HEX HD	HEXAGONAL HEAD	PWR	POWER	TNSN	TENSION
CKT	CIRCUIT	HEX SOC	HEXAGONAL SOCKET	ROPT	RECEPTACLE	TPG	TAPPING
COMP	COMPOSITION	HLCPS	HELICAL COMPRESSION	RES	RESISTOR	TRH	TRUSS HEAD
CONN	CONNECTOR	HLEXT	HELICAL EXTENSION	RGD	RIGID	V	VOLTAGE
COV	COVER	HV	HIGH VOLTAGE	RLF	RELIEF	VAR	VARIABLE
CPLG	COUPLING	IC	INTEGRATED CIRCUIT	RTNR	RETAINER	W/	WITH
CRT	CATHODE RAY TUBE	ID	INSIDE DIAMETER	SCH	SOCKET HEAD	WSHR	WASHER
DEG	DEGREE	IDNT	IDENTIFICATION	SCOPE	OSCILLOSCOPE	XFMR	TRANSFORMER
DWR	DRAWER	IMPLR	IMPELLER	SCR	SCREW	XSTR	TRANSISTOR

## CROSS INDEX—MFR. CODE NUMBER TO MANUFACTURER

Mfr. Code	Manufacturer	Address	City, State, Zip
000BK	STAUFFER SUPPLY	105 SE TAYLOR	PORTLAND, OR 97214
04713	MOTOROLA, INC., SEMICONDUCTOR PROD. DIV.	5005 E MCDOWELL RD, PO BOX 20923	PHOENIX, AZ 85036
07707	USM CORP., USM FASTENER DIV.	510 RIVER RD.	SHELTON, CT 06484
12136	PHILADELPHIA HANDLE COMPANY, INC.	1643 HADDON AVENUE	CAMDEN, NJ 08103
12360	ALBANY PRODUCTS CO., DIV. OF PNEUMO DYNAMICS CORPORATION	145 WOODWARD AVENUE	SOUTH NORWALK, CT 06586
16428	BELDEN CORP.	P. O. BOX 1331	RICHMOND, IN 47374
22526	BERG ELECTRONICS, INC.	YOUK EXPRESSWAY	NEW CUMBERLAND, PA 17070
45722	USM CORP., PARKER-KALON FASTENER DIV.		CAMPBELLSVILLE, KY 42718
57771	STIMPSON, EDWIN B., CO., INC.	900 SYLVAN AVENUE	BAYPORT, NY 11705
70485	ATLANTIC INDIA RUBBER WORKS, INC.	571 W. POLK ST.	CHICAGO, IL 60607
73743	FISCHER SPECIAL MFG. CO.	446 MORGAN ST.	CINCINNATI, OH 45206
75915	LITTELFUSE, INC.	800 E. NORTHWEST HWY	DES PLAINES, IL 60016
77250	PHEOLL MANUFACTURING CO., DIVISION OF ALLIED PRODUCTS CORP.	5700 W. ROOSEVELT RD.	CHICAGO, IL 60650
78189	ILLINOIS TOOL WORKS, INC. SHAKEPROOF DIVISION	ST. CHARLES ROAD	ELGIN, IL 60120
78471	TILLEY MFG. CO.	900 INDUSTRIAL RD.	SAN CARLOS, CA 94070
80009	TEKTRONIX, INC.	P O BOX 500	BEAVERTON, OR 97077
83385	CENTRAL SCREW CO.	2530 CRESCENT DR.	BROADVIEW, IL 60153
86445	PENN FIBRE AND SPECIALTY CO., INC.	2032 E. WESTMORELAND ST.	PHILADELPHIA, PA 19134
86928	SEASTROM MFG. COMPANY, INC.	701 SONORA AVENUE	GLENDALE, CA 91201
93907	CAMCAR SCREW AND MFG. CO.	600 18TH AVE.	ROCKFORD, IL 61101
95238	CONTINENTAL CONNECTOR CORP.	34-63 56TH ST.	WOODSIDE, NY 11377

Fig. & Index No.	Tektronix Part No.	Serial/Model No.		Qty	1 2 3 4 5	Name & Description	Mfr	
		Eff	Dscont				Code	Mfr Part Number
1-1	390-0285-00	B010100	B029999	1		COVER, PWR SPLY: WRAPAROUND	80009	390-0285-00
	390-0285-01	B030000	B089999	1		COVER, PWR SPLY: WRAPAROUND	80009	390-0285-01
	390-0285-02	B090000		1		COVER, PWR SPLY: WRAPAROUND (ATTACHING PARTS)	80009	390-0285-02
-2	211-0622-00	B010100	B029999	2		SCREW, MACHINE: 6-32 X 0.188, TRH, SST, POZ	12360	OBD
	211-0622-00	B030000		4		SCREW, MACHINE: 6-32 X 0.188, TRH, SST, POZ	12360	OBD
-3	212-0112-00	XB060000		1		SCREW, MACHINE: 8-32 X 0.188, TRH, SST - - - * - - -	000BK	OBD
-4	367-0171-00			1		. COVER INCLUDES: . HANDLE, CARRYING: (ATTACHING PARTS)	12136	845-R-372-140-37
-5	210-0586-00	B010100	B089999	2		. NUT, PLAIN, EXT W: 4-40 X 0.25 INCH, STL	78189	211-041800-00
-6	210-0958-00	B010100	B089999	2		. WASHER, FLAT: 0.115 ID X 0.469 INCH OD, STL	78471	OBD
-7	211-0012-00	B010100	B089999	2		. SCREW, MACHINE: 4-40 X 0.375 INCH, PNH STL	83385	OBD
	210-0783-00	B090000		2		. RIVET, BLIND: 0.125 OD X 0.357 L, DOMED HEAD	07707	AD 44 ABS
	210-0993-00	B090000		2		. WSHR, SHOULDERED: 0.143" ID X 0.75" OD, BRS - - - * - - -	86928	OBD
	348-0187-00	B010100	B079999X	4		FOOT, CABINET: 0.780 X 1.650 INCH LONG (ATTACHING PARTS FOR EACH)	80009	348-0187-00
	211-0511-00	B010100	B079999X	1		SCREW, MACHINE: 6-32 X 0.50 INCH, PNH STL	83385	OBD
	348-0026-00	B010100	B079999X	2		HINGE BLOCK, STA: LEFT	80009	348-0026-00
	348-0027-00	B010100	B079999X	2		HINGE BLOCK, STA: RIGHT	80009	348-0027-00
-8	348-0348-00	B010100	B079999	1		STAND, ELEC EQPT:	83385	OBD
	348-0275-00	B080000		1		FLIPSTAND, CAB.:	80009	348-0275-00
-9	390-0274-00	B010100	B062278	1		COVER, PWR SPLY: BOTTOM	80009	390-0274-00
	390-0388-00	B062279	B079999	1		COVER, PWR SPLY: BOTTOM	80009	390-0388-00
	390-0438-01	B080000		1		COVER, PWR SPLY: BOTTOM (ATTACHING PARTS)	80009	390-0438-01
-10	211-0105-00			4		SCREW, MACHINE: 4-40 X 0.188" 100 DEG, FLH STL - - - * - - -	83385	OBD
	390-0438-00	XB080000		1		. CABINET BOTTOM ASSY INCLUDES: . COVER, PWR SPLY: BOTTOM	80009	390-0438-00
-11	348-0208-00	XB080000		2		. FOOT, CABINET: LEFT FRONT AND RIGHT REAR	80009	348-0208-00
-12	348-0073-00	XB080000		2		. HINGE BLOCK, STA: L FR, R REAR, BLACK ACETAL (ATTACHING PARTS)	80009	348-0073-00
	211-0532-00	XB080000		2		. SCREW, MACHINE: 6-32 X 0.75 INCH, FILH STL	83385	OBD
-14	210-0457-00	XB080000		2		. NUT, PLAIN, EXT W: 6-32 X 0.312 INCH, STL - - - * - - -	83385	OBD
-15	348-0207-00	XB080000		2		. FOOT, CABINET: RIGHT FRONT AND LEFT REAR	80009	348-0207-00
-16	348-0074-00	XB080000		2		. HINGE BLOCK, STA: R FR, L REAR, BLACK ACETAL (ATTACHING PARTS)	80009	348-0074-00
-17	211-0532-00	XB080000		2		. SCREW, MACHINE: 6-32 X 0.75 INCH, FILH STL	83385	OBD
-18	210-0457-00	XB080000		2		. NUT, PLAIN, EXT W: 6-32 X 0.312 INCH, STL - - - * - - -	83385	OBD
-19	351-0334-00	B010100	B029999	3		GUIDE, PL-IN UNI:	80009	351-0334-00
	351-0379-01	B030000		3		GUIDE, PL-IN: UPPER (ATTACHING PARTS FOR EACH)	80009	351-0379-01
-20	213-0254-00	B010100	B029999	1		SCREW, TPG, TF: 2-32 X 0.250, 100 DEG, FLH	45722	OBD
	211-0087-01	B030000		1		SCREW, MACHINE: 2-56 X 0.188" 82 DEG, FLH, STL - - - * - - -	83385	OBD
-21	351-0286-00	B010100	B019999	3		GUIDE, PL-IN UNI:	80009	351-0286-00
	351-0286-01	B020000	B069999	3		GUIDE, PL-IN UNI:	80009	351-0286-01
	351-0286-02	B070000	B089999	3		GUIDE, PL-IN UNI:	80009	351-0286-02
	351-0286-04	B090000	B121599	3		GUIDE, PL-IN UNI: LOWER, BLACK NYLON	80009	351-0286-04
	351-0286-07	B121600		3		GUIDE, PL-IN UNI: LOWER NYLON (ATTACHING PARTS)	80009	351-0286-07
-22	211-0101-00	B010100	B121599	1		SCREW, MACHINE: 4-40 X 0.25" 100 DEG, FLH STL	83385	OBD
	213-0814-00	B121600		1		SCREW, TPG TR: 4-20, 0.25 L, PLASTITE	93907	OBD
-23	211-0038-00	B010100	B121599	2		SCREW, MACHINE: 4-40 X 0.312" 100 DEG, FLH STL	83385	OBD
	213-0813-00	B121600		2		SCREW, TPG, TR: 4-20, 0.312 L, PLASTITE - - - * - - -	93907	OBD
-24	131-1254-00			3		CONTACT, ELEC: GROUNDING, PH BRZ (ATTACHING PARTS)	80009	131-1254-00
-25	210-0617-00			3		EYELET, METALLIC: 0.089 OD X 0.125" L, BRASS - - - * - - -	57771	G53-4

Replaceable Mechanical Parts—TM 503

Fig. & Index No.	Tektronix Part No.	Serial/Model No. Eff	Dscont	Qty	1 2 3 4 5	Name & Description	Mfr Code	Mfr Part Number
1-26	384-1166-00	B010100	B029999	1		EXTENSION SHAFT:13.612 L X 0.048 STL W/PB	80009	384-1166-00
	384-1166-01	B030000		1		EXTENSION SHAFT:13.612 L X 0.048 STL W/PB	80009	384-1166-01
						(ATTACHING PARTS)		
-27	211-0101-00	B010100	B121599	2		SCREW,MACHINE:4-40 X 0.25" 100 DEG,FLH STL	83385	OBD
	212-0815-00	B121600		2		SCREW,TPG TR:4-20,0.188 L,PLASTITE	93907	OBD
						- - - * - - -		
-28	214-1790-00			1		ADAPTR,SW ACTR:POWER	80009	214-1790-00
-29	-----			1		SWITCH,PUSH-PUL:10A,250VAC(SEE S2 EPL)		
-30	-----			1		CKT BOARD ASSY:INTERFACE(SEE A1 EPL)		
-31	131-0608-00			14		. TERMINAL,PIN:0.365 L X 0.25 PH,BRZ,GOLD PL	22526	47357
-32	131-1078-00			3		. CONNECTOR,RCPT,:28/56 CONTACT	95238	600-1156Y256DF30
-33	214-1593-02			3		. KEY,CONN PLZLN:CKT BD CONN	80009	214-1593-02
-34	344-0154-00			4		. CLIP,ELECTRICAL:FOR 0.25 INCH DIA FUSE	80009	344-0154-00
-35	352-0322-00			1		. RETAINER,CAP.: (ATTACHING PARTS)	80009	352-0322-00
-36	211-0534-00			2		. SCR,ASSEM,WSHR:6-32 X 0.312 INCH,PNH STL	83385	OBD
-37	210-0407-00			2		. NUT,PLAIN,HEX.:6-32 X 0.25 INCH,BRS	73743	3038-0228-402
						- - - * - - -		
-38	131-1895-00			1		LINK,TERM. CONN:8,22 AWG,1.5 L	80009	131-1895-00
-39	131-1896-00			1		LINK,TERM. CONN:8,22 AWG,1.5 L	80009	131-1896-00
-40	386-1938-00			1		REINF,CKT BD:INTERFACE (ATTACHING PARTS)	80009	386-1938-00
-41	211-0008-00	B010100	B074839	4		SCREW,MACHINE:4-40 X 0.25 INCH,PNH STL	83385	OBD
-42	210-0586-00	B010100	B074839	4		NUT,PLAIN,EXT W:4-40 X 0.25 INCH,STL	78189	211-041800-00
	210-0777-00	B074840		4		RIVET,BLIND:0.125 DIA GRIP,AL (ATTACHING PARTS FOR CKT BD ASSY)	45722	AD42AB5
-43	211-0510-00			2		SCREW,MACHINE:6-32 X 0.375 INCH,PNH STL	83385	OBD
-44	220-0546-00			2		NUT,CHASSIS MTC:6-32 X 0.312 OD X 0.312 L	80009	220-0546-00
-45	210-0457-00			6		NUT,PLAIN,EXT W:6-32 X 0.312 INCH,STL	83385	OBD
-46	210-0071-00			6		WASHER,SPR TNSN:0.146 ID X 0.323" OD,STL	78189	4706-05-01-0531
-47	342-0136-00			6		INSULATOR,WSHR:0.812 OD X 0.0025 INCH THK	04713	OBD
						- - - * - - -		
-48	214-1764-00			1		HEAT SINK,XSTR:ALUMINUM	80009	214-1764-00
-49	214-1791-00			1		HEAT SINK,XSTR:ALUMINUM	80009	214-1791-00
-50	-----			2		SWITCH,THERMO:(SEE S3,S4 EPL) (ATTACHING PARTS FOR EACH)		
-51	211-0008-00			2		SCREW,MACHINE:4-40 X 0.25 INCH,PNH STL	83385	OBD
-52	210-0586-00			2		NUT,PLAIN,EXT W:4-40 X 0.25 INCH,STL	78189	211-041800-00
						- - - * - - -		
-53	358-0365-00			1		BSHG,STRAIN RLF:	80009	358-0365-00
-54	161-0033-04	B010100	B120989	1		CABLE ASSY,PWR:	16428	KH854-2
	161-0033-05	B120990		1		CABLE ASSY,PWR:3,18 AWG,125V,92.0 L	80009	161-0033-05
-55	348-0190-00	XB080000	B099999	4		FOOT,CABINET:	80009	348-0190-00
	348-0191-00	B100000		4		LEG,ELEC EQUIP.:PLASTIC (ATTACHING PARTS)	80009	348-0191-00
-56	212-0022-00	XB080000		4		SCREW,MACHINE:8-32 X 1.5 INCH,PNH,STL	83385	OBD
-57	210-0458-00	XB080000		4		NUT,PLAIN,EXT W:8-32 X 0.344 INCH,STL	83385	OBD
						- - - * - - -		
	210-0205-00			1		TERMINAL,LUG:SE #8	78189	2104-08-00-2520N
-58	200-0772-02			1		COVER,ELEC XFMR:3.125 X 3.75 X 0.875 (ATTACHING PARTS)	80009	200-0772-02
-59	212-0516-00	B010100	B039999	4		SCREW,MACHINE:10-32 X 2 INCH,HEX HD STL	77250	OBD
	212-0515-00	B040000		4		SCREW,MACHINE:10-32 X 2.250" HEX.HD STL	83385	OBD
-60	220-0410-00			4		NUT,EXTENDED WA:10-32 X 0.375 INCH,STL	83385	OBD
-61	166-0227-00			4		INS SLV,ELEC:0.187 ID X 1.50 INCH LONG	80009	166-0227-00
-62	210-0812-00	XB050000	B074839	4		WASHER,NONMETAL:#10,FIBER	86445	OBD
	210-0010-00	B074840		4		WASHER,LOCK:INT,0.20 ID X0.376" OD,STL	78189	1210-00-00-0541C
-63	210-0206-00	XB074840		1		TERMINAL,LUG:SE #10	86928	A373-147-1
-64	-----			1		TRANSFORMER:(SEE T1 EPL)		
-65	333-1597-00	B010100	B079999	1		PANEL,REAR:	80009	333-1597-00
	333-1901-00	B080000		1		PANEL,REAR:	80009	333-1901-00
	333-1701-00	B010100	B079999	1		PANEL,REAR: (OPTION 2)	80009	333-1701-00
	-----			-				
	333-1900-00	B080000		1		PANEL,REAR: (OPTION 2)	80009	333-1900-00
	-----			-				
						(ATTACHING PARTS)		
-66	211-0510-00	XB080000		2		SCREW,MACHINE:6-32 X 0.375 INCH,PNH STL	83385	OBD
-67	210-0457-00	XB080000		2		NUT,PLAIN,EXT W:6-32 X 0.312 INCH,STL	83385	OBD
						- - - * - - -		

Fig. & Index No.	Tektronix Part No.	Serial/Model No.		Qty	1 2 3 4 5	Name & Description	Mfr	
		Eff	Dscont				Code	Mfr Part Number
1-68	352-0076-00	B010100	B049999	1		FUSEHOLDER:W/HARDWARE	75915	342012-L
	352-0362-00	B050000		1		FUSEHOLDER: W/MOUNTING HARDWARE	75915	345001
-69	210-0873-00			1		WASHER, NONMETAL:0.5 ID X 0.688 INCH OD, NPRN	70485	OBD
-70	407-1062-00	B010100	B114739	1		BRACKET, ANGLE:CKT BOARD, RIGHT, ALUMINUM	80009	407-1062-00
	407-1062-01	B114740		1		BRACKET, ANGLE:CKT BOARD, RIGHT, ALUMINUM (ATTACHING PARTS)	80009	407-1062-01
-71	211-0507-00			2		SCREW, MACHINE:6-32 X 0.312 INCH, PNH STL	83385	OBD
-72	210-0457-00			2		NUT, PLAIN, EXT W:6-32 X 0.312 INCH, STL - - - * - - -	83385	OBD
-73	407-1178-00	B010100	B114739	1		BRACKET, ANGLE:CKT BOARD, LEFT, ALUMINUM	80009	407-1178-00
	407-1178-01	B114740		1		BRACKET, ANGLE:CKT BOARD, LEFT, ALUMINUM (ATTACHING PARTS)	80009	407-1178-01
-74	211-0507-00			2		SCREW, MACHINE:6-32 X 0.312 INCH, PNH STL	83385	OBD
-75	210-0457-00			2		NUT, PLAIN, EXT W:6-32 X 0.312 INCH, STL - - - * - - -	83385	OBD
-76	210-0204-00			1		TERMINAL, LUG:0.146 INCH DIA DE, 45 DEG BEND (ATTACHING PARTS)	78189	2157-06-01-2520N
-77	210-0586-00			1		NUT, PLAIN, EXT W:4-40 X 0.25 INCH, STL - - - * - - -	78189	211-041800-00
-78	426-0919-00	B010100	B029999	1		FRAME ASSY, CAB.:	80009	426-0919-00
	426-0919-01	B030000	B079999	1		FRAME ASSY, CAB.:	80009	426-0919-01
	426-0919-02	B080000	B106689	1		FRAME ASSY, CAB.:	80009	426-0919-02
	426-0919-04	B106690		1		FRAME SECT, CAB.:	80009	426-0919-04
	334-2709-00			1		MARKER, IDENT:MARKED "CAUTION"	80009	334-2709-00
	334-2037-00			2		MARKER, IDENT:	80009	334-2037-00
	334-3379-01	XB119080		1		MARKER, IDENT:MARKED GROUND SYMBOL	80009	334-3379-01

1  
2  
3  
4  
5  
6  
7  
8  
9  
10  
11  
12  
13  
14  
15  
16  
17  
18  
19  
20  
21  
22  
23  
24  
25  
26  
27  
28  
29  
30  
31  
32  
33  
34  
35  
36  
37  
38  
39  
40  
41  
42  
43  
44  
45  
46  
47  
48  
49  
50  
51  
52  
53  
54  
55  
56  
57  
58  
59  
60  
61  
62  
63  
64  
65  
66  
67  
68  
69  
70  
71  
72  
73  
74  
75  
76  
77  
78  
79  
80  
81  
82  
83  
84  
85  
86  
87  
88  
89  
90  
91  
92  
93  
94  
95  
96  
97  
98  
99  
100

FIG. 1 EXPLODED

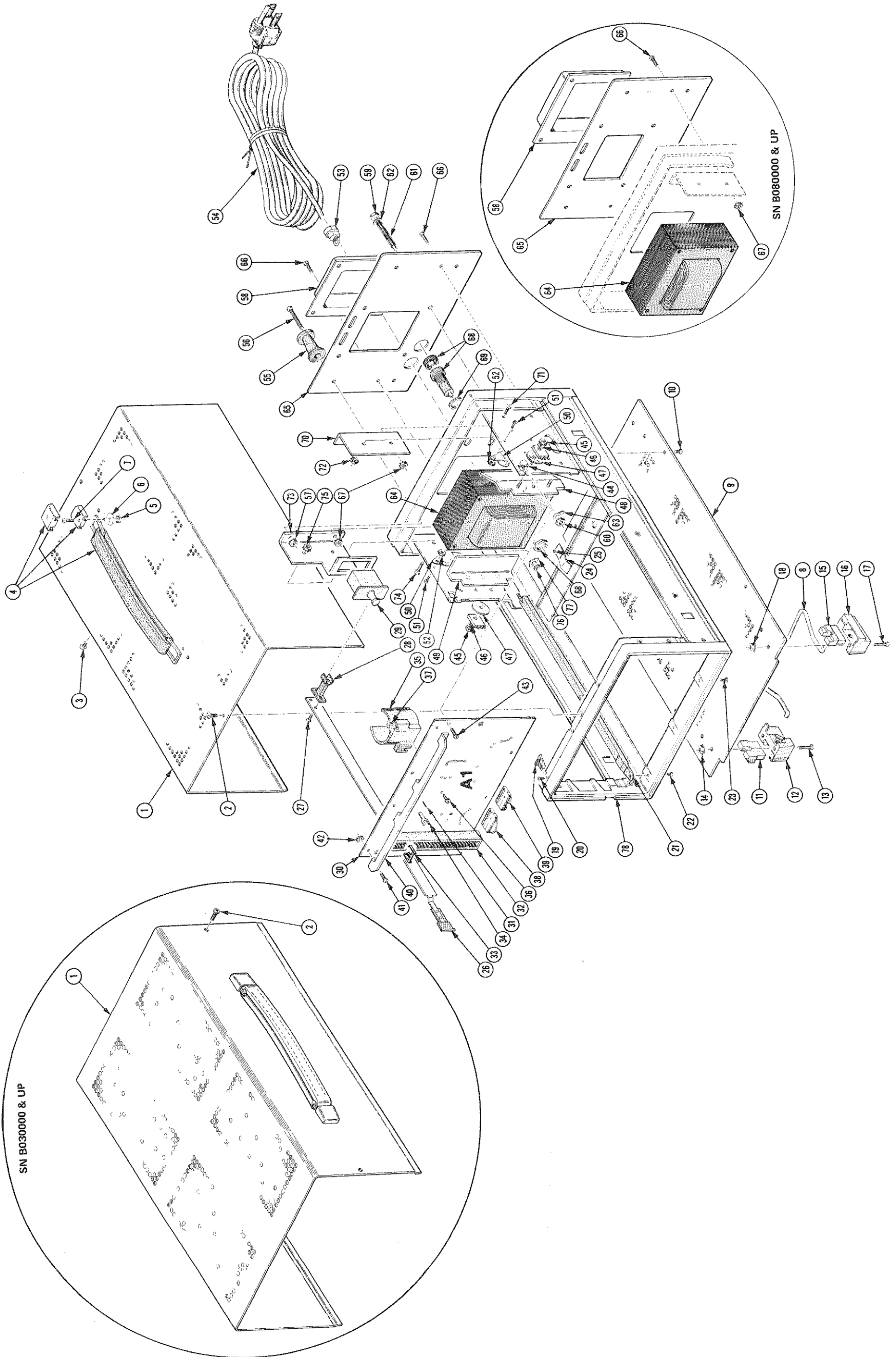

TM 503 POWER MODULE

REV D, JAN 1979

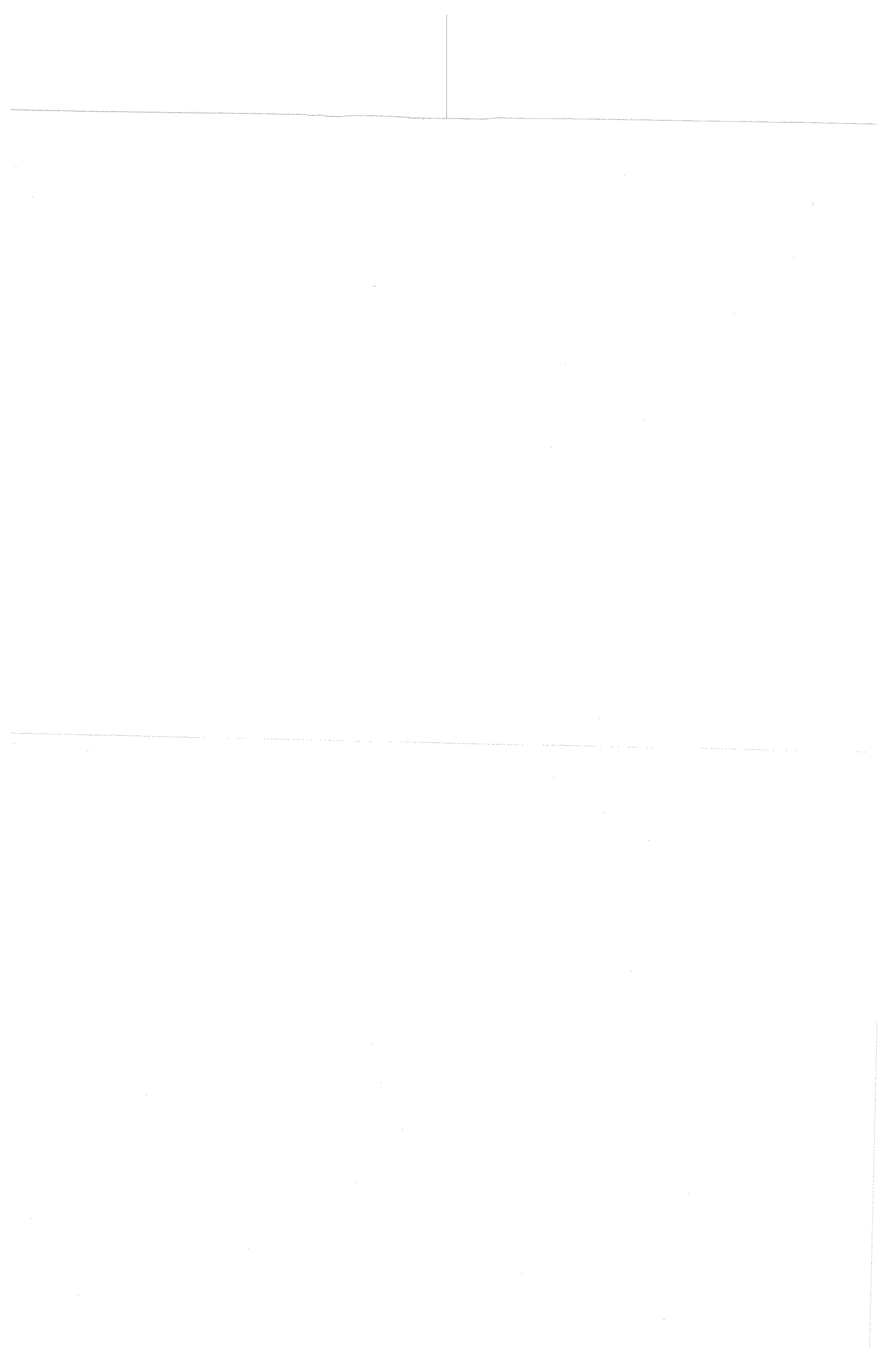



STANDARD ACCESSORIES

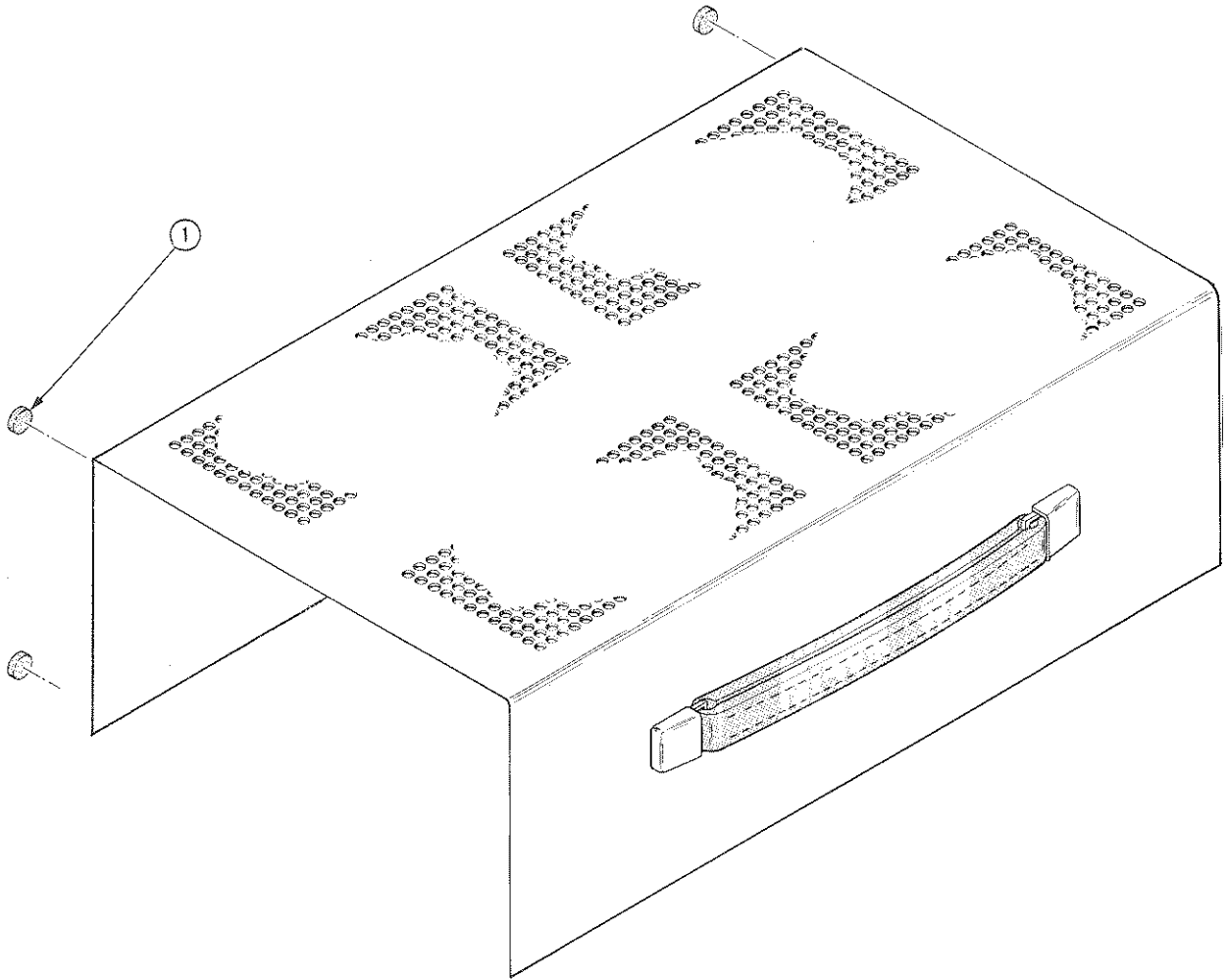

Fig. &

Index No.	Tektronix Part No.	Serial/Model No. Eff	Model No. Dscont	Qty	1	2	3	4	5	Name & Description	Mfr Code	Mfr Part Number
-1	348-0429-00			4						BUMPER, PLASTIC: 0.45 DIA X 0.195 GRAY POLY	19898	SJ-5003
	070-1305-00			1						MANUAL, TECH: INSTRUCTION	80009	070-1305-00

1  
2  
3  
4  
5  
6  
7  
8  
9  
10  
11  
12  
13  
14  
15  
16  
17  
18  
19  
20  
21  
22  
23  
24  
25  
26  
27  
28  
29  
30  
31  
32  
33  
34  
35  
36  
37  
38  
39  
40  
41  
42  
43  
44  
45  
46  
47  
48  
49  
50  
51  
52  
53  
54  
55  
56  
57  
58  
59  
60  
61  
62  
63  
64  
65  
66  
67  
68  
69  
70  
71  
72  
73  
74  
75  
76  
77  
78  
79  
80  
81  
82  
83  
84  
85  
86  
87  
88  
89  
90  
91  
92  
93  
94  
95  
96  
97  
98  
99  
100

## **MANUAL CHANGE INFORMATION**

At Tektronix, we continually strive to keep up with latest electronic developments by adding circuit and component improvements to our instruments as soon as they are developed and tested.

Sometimes, due to printing and shipping requirements, we can't get these changes immediately into printed manuals. Hence, your manual may contain new change information on following pages.

A single change may affect several sections. Since the change information sheets are carried in the manual until all changes are permanently entered, some duplication may occur. If no such change pages appear following this page, your manual is correct as printed.

## **SERVICE NOTE**

Because of the universal parts procurement problem, some electrical parts in your instrument may be different from those described in the Replaceable Electrical Parts List. The parts used will in no way alter or compromise the performance or reliability of this instrument. They are installed when necessary to ensure prompt delivery to the customer. Order replacement parts from the Replaceable Electrical Parts List.

# CALIBRATION TEST EQUIPMENT REPLACEMENT

## Calibration Test Equipment Chart

This chart compares TM 500 product performance to that of older Tektronix equipment. Only those characteristics where significant specification differences occur, are listed. In some cases the new instrument may not be a total functional replacement. Additional support instrumentation may be needed or a change in calibration procedure may be necessary.

### Comparison of Main Characteristics

DM 501 replaces 7D13		
PG 501 replaces 107	PG 501 - Risetime less than 3.5 ns into 50 $\Omega$ .	107 - Risetime less than 3.0 ns into 50 $\Omega$ .
108	PG 501 - 5 V output pulse; 3.5 ns Risetime	108 - 10 V output pulse 1 ns Risetime
PG 502 replaces 107		
108	PG 502 - 5 V output	108 - 10 V output
111	PG 502 - Risetime less than 1 ns; 10 ns Pretrigger pulse delay	111 - Risetime 0.5 ns; 30 to 250 ns Pretrigger pulse delay
PG 508 replaces 114	Performance of replacement equipment is the same or better than equipment being replaced.	
115		
2101		
PG 506 replaces 106	PG 506 - Positive-going trigger output signal at least 1 V; High Amplitude output, 60 V.	106 - Positive and Negative-going trigger output signal, 50 ns and 1 V; High Amplitude output, 100 V.
067-0502-01	PG 506 - Does not have chopped feature.	0502-01 - Comparator output can be alternately chopped to a reference voltage.
SG 503 replaces 190, 190A, 190B	SG 503 - Amplitude range 5 mV to 5.5 V p-p.	190B - Amplitude range 40 mV to 10 V p-p.
191	SG 503 - Frequency range 250 kHz to 250 MHz.	0532-01 - Frequency range 65 MHz to 500 MHz.
067-0532-01		
SG 504 replaces 067-0532-01	SG 504 - Frequency range 245 MHz to 1050 MHz.	0532-01 - Frequency range 65 MHz to 500 MHz.
067-0650-00		
TG 501 replaces 180, 180A	TG 501 - Trigger output-slaved to marker output from 5 sec through 100 ns. One time-mark can be generated at a time.	180A - Trigger pulses 1, 10, 100 Hz; 1, 10, and 100 kHz. Multiple time-marks can be generated simultaneously.
181	TG 501 - Trigger output-slaved to market output from 5 sec through 100 ns. One time-mark can be generated at a time.	181 - Multiple time-marks
184		184 - Separate trigger pulses of 1 and 0.1 sec; 10, 1, and 0.1 ms; 10 and 1 $\mu$ s.
2901	TG 501 - Trigger output-slaved to marker output from 5 sec through 100 ns. One time-mark can be generated at a time.	2901 - Separate trigger pulses, from 5 sec to 0.1 $\mu$ s. Multiple time-marks can be generated simultaneously.

**NOTE: All TM 500 generator outputs are short-proof. All TM 500 plug-in instruments require TM 500-Series Power Module.**



**TEKTRONIX®**

committed to  
technical excellence

# MANUAL CHANGE INFORMATION

PRODUCT TM 503, TM 504,  
TM 506, & TM 515

CHANGE REFERENCE OPTION 7  
DATE 4-20-76 REV. 10-25-76

CHANGE:

DESCRIPTION

## OPTION 7

TM 503, TM 504, TM 506, and TM 515

The following described bus wires and keys are added to the connector boards of the above named TM 500-Series Power Modules to provide rear interface connections between the DC 502 Option 7, the TR 502, and the SW 503.

Bus Wires. Six-conductor ribbon cable (Tektronix Part No. 175-0829-00) is used to make bus runs between the following points:

TM 503, TM 504, TM506 and TM515

B14 on J10, J20, and J30

B15 on J10, J20, and J30

B16 on J10, J20, and J30

B17 on J10, J20, and J30

B18 on J10, J20, and J30

A18 on J10, J20, and J30

Barrier Keys. Plastic barrier keys (Tektronix Part No. 214-1593-02) are inserted between pins 21 and 22 on J10 between pins 23 and 24 on J20 and between pins 17 and 18 on J30.

Once the above bus connections are made and barrier keys inserted, the three connectors so changed are system dedicated and the three slots should only be used for system-dedicated plug-ins.

1  
2  
3  
4  
5  
6  
7  
8  
9  
10  
11  
12  
13  
14  
15  
16  
17  
18  
19  
20  
21  
22  
23  
24  
25  
26  
27  
28  
29  
30  
31  
32  
33  
34  
35  
36  
37  
38  
39  
40  
41  
42  
43  
44  
45  
46  
47  
48  
49  
50  
51  
52  
53  
54  
55  
56  
57  
58  
59  
60  
61  
62  
63  
64  
65  
66  
67  
68  
69  
70  
71  
72  
73  
74  
75  
76  
77  
78  
79  
80  
81  
82  
83  
84  
85  
86  
87  
88  
89  
90  
91  
92  
93  
94  
95  
96  
97  
98  
99  
100